

SYSTEM ELPRESS

PRODUCT CATALOGUE

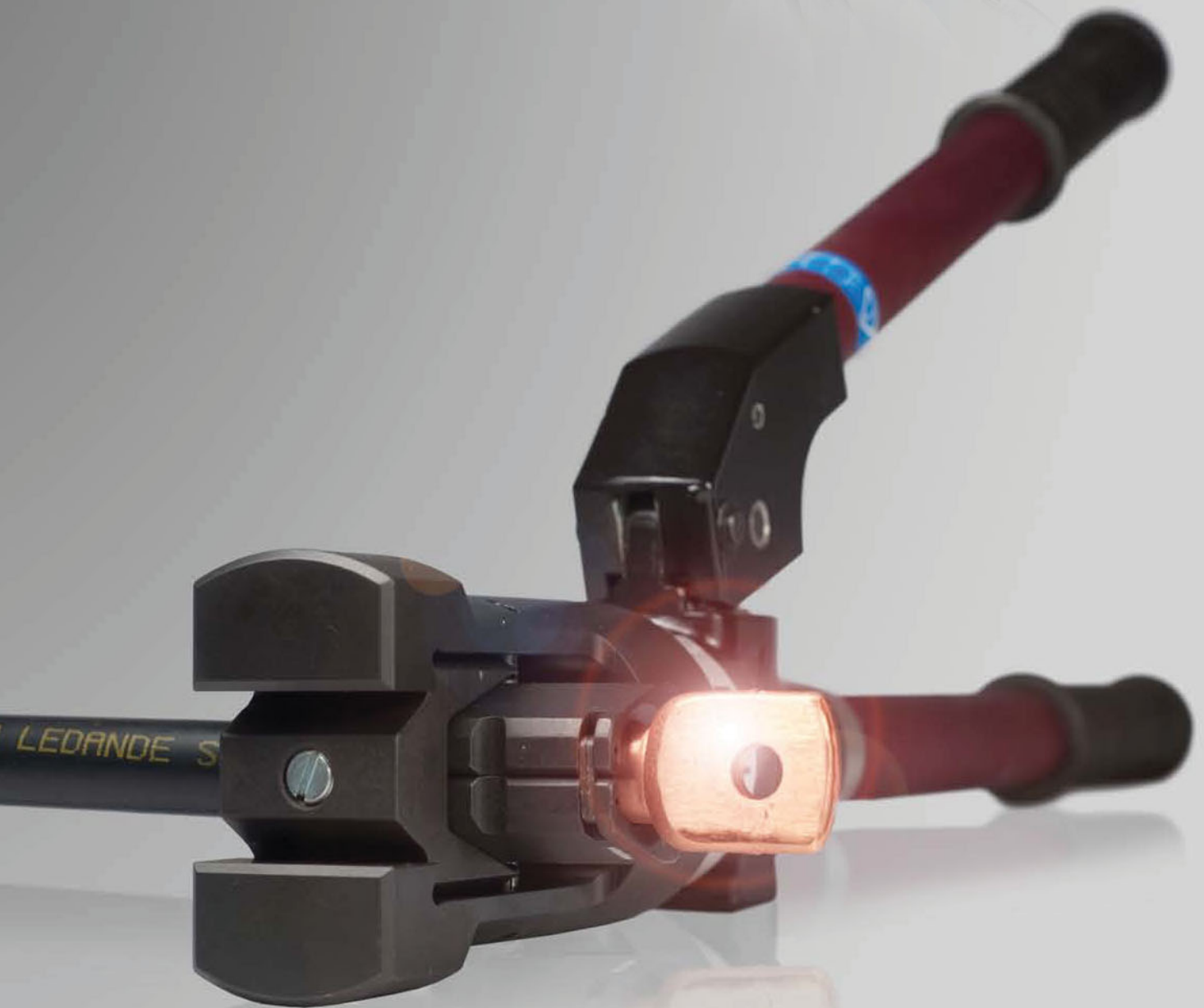

ELPRESS®



Business aim

“The business aim of the Elpress Group is to provide, primarily to professional Nordic and global users, qualified material and knowledge concerning electrical applications, with a high level of service and product expertise.”

Contact us

Head office



Elpress AB
Industrivägen 15
P.O. Box 186
SE-872 24 Kramfors, Sweden
Tel +46 612 71 71 00
sales@elpress.se
www.elpress.net

Customer support
Tel +46 612 71 71 99
support@elpress.se

Order
Tel +46 612 71 71 70
Fax +46 612 71 71 71
order@elpress.se

Market department
Tel +46 612 71 71 50
Fax +46 612 71 71 51
sales@elpress.se

Sales offices/subsidiaries



Elpress GmbH
Kränkelsweg 24
DE-417 48 Viersen, Germany
Tel +49 2162 93 19-0
Fax +49 2162 350403
sales@elpress.de
www.elpress.de



Elpress A/S
Randersvej 16
DK-8600 Silkeborg, Denmark
Tel +45 8681 61 11
Fax +45 8681 61 16
salg@elpress.dk
www.elpress.dk



Elpress (Beijing) Electrical Components Co., Ltd
Rm 1605, Diyang Tower,
No. H2 Dongsanhuan Bei Lu,
Chaoyang District,
Beijing 100027, P.R. China
Tel: +86 10 65005642
Fax: +86 10 64385279
info@elpress.com.cn
www.elpress.com.cn



Area Manager Norway
Tel +47 91 68 55 02



Area Manager Finland
Tel +358 40 538 96 44

The information contained in this catalogue is for commercial use to select products only. It is not intended for use in QA instructions, production drawings, instruction manuals or likewise. If such documentation is required, please contact your nearest Elpress representative or Elpress directly. Although every effort has been made to ensure correct and updated information at time of printing, Elpress makes reservation for misprints, wrong or outdated information and changes. Elpress reserve the right to change, update or discontinue products without prior notice. This catalogue is the property of Elpress. Any reproduction in full, part or of pictures, is forbidden without prior written permission from Elpress AB.



SYSTEM ELPRESS



Pre-insulated terminals 0.1 - 6 mm² and tools

1



End terminals (ferrules) 0.14 - 50 mm² and tools

2



Un-insulated terminals 0.2 - 10 mm² and tools

3



Cu terminals and connectors 0.75 - 1000 mm²

4



Al and AlCu terminals and connectors 16 - 1200 mm²

5



Tools for crimping Cu, Al and AlCu terminals and connectors

6



Overhead connectors 10 - 241 mm² and tools

7



Screw connectors

8



Cutting and stripping tool

9



Deep earthing

10

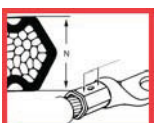

General information

11



Certification and standards



Environment policy

Within ELPRESS AB we shall always work with ongoing improvements reducing our influence on the environment. This shall be achieved by using resources in an environment promoting way and by reducing the amount of emissions and waste. We shall meet the legal requirements with a good margin. Our products shall be designed to minimise environmental influence related to

- Manufacture
- Use, and
- Final disposal

All ingredients, materials and components with a negative environment influence shall gradually be exchanged. Our processes as well as our places and methods of work shall be designed and adapted in order to minimise environmental influence and to avoid injury and health hazard to persons.

Information and training shall constitute normal activities in the company to stimulate interest in environment issues with all ELPRESS' employees and to support personal development and participation in the environment work of the company.

Our suppliers and commissioned partners shall be chosen and influenced in such a way that they can add to our fulfilment of the environment policy.

Our customers shall be informed of our environment work and form co-operation partners to spread knowledge and advice

to the parties of the distribution chain, all in order to safeguard the proper use, stocking and final disposal of our products.

We shall continuously evaluate the results of the environment work. We shall demonstrate openness concerning information on our work and our effect on the environment.



Quality

For us, quality means trying all the time to be the best in the business. That's why we are constantly developing our products, methods and ourselves, since knowledge is perhaps the most important component for achieving the highest quality. Our work on quality has resulted in Elpress being certified to ISO 9001 since 1992.

Our certificate, with number FM20987, is issued by the internationally recognized BSI, British Standards Institution, of England.

Verification of products

There are quite a lot of different test standards and approval routines that may be applied on cable connectors and terminations. Due to this and the variation in contents between standards from different countries one has to make a selection. Elpress had previously applied primarily Swedish, UK and German standards but lately IEC and EN Standards, where the latter rapidly will substitute the old national standards. In many cases there are also reason for special approvals like Det Norske Veritas, UL and others.



IEC - International Electrical Commission - issues international standards which, although not always compulsory, do have strong influence and are used as a basis within the international terminal trade.



CSA, Canadian Standards Association, is a Canadian organization that certifies products according to American standards. Elpress end terminals of the type A..ET/ETT/ETD, B...ET, A...ET2/ETT2/ETW2 is CSA certified according to the American Standards C22.2 No. 158 and UL 1059 under file No. 247206. End terminals of the type A..ET/B...ET/A...ET2 is for use with stranded Cu-conductors 26 AWG to 500 MCM, corresponding to the metric size of 0.14 mm² to 240 mm². For use with Elpress professional crimping tools.



DNV - Det Norske Veritas Elpress KRF/KSF, KRT/KST terminals comply with DNV's rules for the classification of ships and Det Norske Veritas' Offshore Standards. The terminals are approved for installations on ships and mobile offshore units.



UL is an American standard which is also internationally accepted. Elpress standard Cu terminals of types KR/KS, KRF/KSF and KRT/KST, are UL approved according to no. E205350. Cu terminals of types KR/KS, KRF/KSF are for stranded and flexible copper wires, classes 2 and 5 according to IEC 60228, and have a working area of 1-500 mm². Cu terminals of types KRT/KST is used for stranded copper wires 10-500 mm².



Pre-insulated terminals and tools

General information about pre-insulated terminals	2
Hand tools for pre-insulated terminals	3
Ring terminals 0.1 - 6 mm ²	4
Fork terminals 0.1 - 6 mm ²	5
Flanged fork terminals 0.5 - 2.5 mm ²	5
Hook terminals 0.5 - 2.5 mm ²	5
Pin terminals 0.1 - 6 mm ²	6
Blade terminals 0.25 - 6 mm ²	6
Through connectors 0.25 - 6 mm ²	6
Through connectors with heat shrink insulation 0.5 - 6 mm ²	7
Parallel connectors 0.5 - 6 mm ²	7
Receptacles 0.1 - 6 mm ²	8
Multiple tabs 0.5 - 2.5 mm ²	8
Receptacles, fully insulated 0.5 - 6 mm ²	9
Tabs 0.5 - 6 mm ²	9
End connectors, fully insulated, 1 - 6 mm ²	9
Bullets 0.25 - 6 mm ²	10
Sockets, fully insulated 0.25 - 6 mm ²	10
Assortment boxes	11
Hobby tools for crimping terminals 0.5 - 6 mm ²	13
Certified crimp tools for pre-insulated terminals 0.14 - 2.5 mm ²	14
Certified Miniforce tools for pre-insulated terminals 0.5 - 6 mm ²	16
Elpress Mobile - a tool with interchangeable dies	18
Battery powered crimp tool	21



General information about pre-insulated terminals

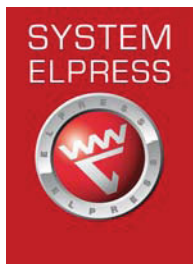

System Elpress

System Elpress consists of connectors and tools tested together for optimum connection result. The System concept makes you as a customer able to feel secure when using our system and to be sure a safe connection is made when Elpress products are used correctly.

Pre-insulated terminals

Elpress ring, fork and pin terminals are manufactured from high grade copper and receptacles from brass or tin-bronze. All terminals are electrolytically tin plated to achieve good corrosion protection. The necks of the terminals are brazed and annealed to allow crimping in any direction around the neck. The metal in the receptacles neck is double folded for excellent mechanical strength and electrical conductivity.

Insulation

Elpress insulation sleeves are moulded in polycarbonate which has excellent deformation characteristics and maintains its vibration support up to high temperatures, well over 100° C. Caution must be taken at alkalic exposure. The colour of the insulation sleeve relates to which cross section area the terminal accepts:

Light yellow sleeve	0.1 - 0.5 mm ²
Green sleeve*	0.25 - 0.75 mm ²
Red sleeve	0.5 - 1.5 mm ²
Blue sleeve	1.5 - 2.5 mm ²
Yellow sleeve	4 - 6 mm ²

* or transparent white

The following table shows the properties for Elpress pre-insulated terminals. Note the properties are general since the influences of environment, temperature, etc. can affect connections. Polycarbonate/PC, and Polyamid/PA, are halogen-free, meaning they do not contain any of the substances fluorine, chlorine, bromine or iodine.

Insulation material	Temperature area	Halogen free	Flammability class, UL94
PA (Polyamid)	70-90°	Yes	V0
PC (Polycarbonate)	90-100°	Yes	V2
PVC (Polyvinylchloride)	60°	No, chlorine	V0

EasyEntry

Most Elpress insulation sleeves are of EasyEntry type which guides all the conductor strands properly into the terminal neck. The risk for back-folded strands, possibly resulting in flash-overs and reduced crimped cross section area, is therefore minimised.

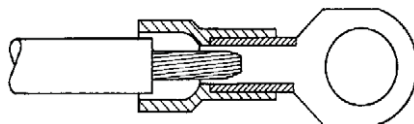

EasyEntry.

Marking of the pre-insulated terminals

Elpress pre-insulated terminals are, if possible, marked with logotype, nominal max cross section area (mm²) and possible metric stud hole size. This simplifies the identification and inspection.

When crimping with Elpress tools an imprint is made on the insulation to make visible which die nest has been used. Elpress GSA tools also leave a logo imprint to indicate Elpress system crimps, traceable to adequate test standards.



Samples of Elpress crimped pre-insulated terminals.

Example of Cat. no.
Cat. no. A1532R (E, FLS, G etc)
A = pre-insulated
15 = cross section area (1,5 mm ²)
32 = characteristic size (stud hole 3,2 mm)
E = end connectors
FLS = receptacles, rolled type
FLSF = receptacles, fully insulated rolled type
FLSH = multiple tabs, rolled type (piggy back)
FLST = receptacles, rolled type, tin-bronze
G = fork terminals
GB = flanged fork terminals
H = tabs (male)
HA = bullets (male)
HO = sockets (female)
K = hook terminals
PSK = parallel connectors
R = ring terminals
SF = blade terminals
SFB = blade terminals (flanged)
SFK = blade terminals
SFL = blade terminals
SFN = blade terminals (with tab)
SR = pin terminals
SRK = pin terminals
SK = through connectors
SKW = through connectors with heat shrink insulation



Crimping of Elpress pre-insulated ring terminal with hand tool GSA0760.



Hand tools for pre-insulated terminals

Mechanical hand tools

High quality, crimp performance and ergonomics are prime considerations of Elpress when developing mechanical crimp tools. Except for the hobby tools, all Elpress crimp tools have a full closure, ratchet mechanism to ensure correct crimps at all instances - a prerequisite for professional and quality assured work.



Elpress Mobile, a professional crimp tool with interchangeable dies.

Miniforce tool

With the unique Miniforce range of crimp tools, a new level of performance was established when speaking of ergonomic adaption to the user and of low handle forces needed. A reduction of required force up to 45% is reached as a result of advanced ergonomic studies where minimised risk for work discomfort or even injuries was the main objective.



Miniforce type C has extra long handles for an easy two-hand grip which in most

cases represents a simple and natural way of lowering work loads.

Elpress tools and terminals/connectors together form a Crimp System where the crimp results are supervised to meet requirements of established standards like IEC60352-2, SEN 245010, DIN46249, BS4579:1 and other.

Many of the most common tools have symmetrical crimp die nests to enable crimps from both tool sides - a feature certainly appreciated by left-handed users.

All Miniforce type G- and D-tools are produced from high grade Swedish steel with black finish surface and comprehensive laser markings.



Certification of crimp tools

Quality assurance of our tools is made by certification, already in the manufacturing process, of the crimping tools, both hand tools type Gxx, i.e. the Miniforce tools, and type Dxx tools.



What is certified?

The certification of Elpress crimp tools comprises individual documentation from final assembly and inspection regarding:

- **handle pre-load**, which is the force needed to release the crimp completion ratchet
- **crimp die nest heights**, which means each of the greatest nest heights to be measured with completely closed dies.

Why certification?

The certificate that accompanies the tool has several functions:

- New crimp tools are often immediately introduced into a QA system. The tool status before use is then of course to

be the first log entry. Later periodic inspection recordings may then form base for detection of changes or wear and of possibly necessary corrective actions.

- The certificate shows that each individual tool meets the design specifications before supply.
- The certificate indicates the most important tool properties to be followed up.

Elpress service department offers continued follow up on the quality of the tools.

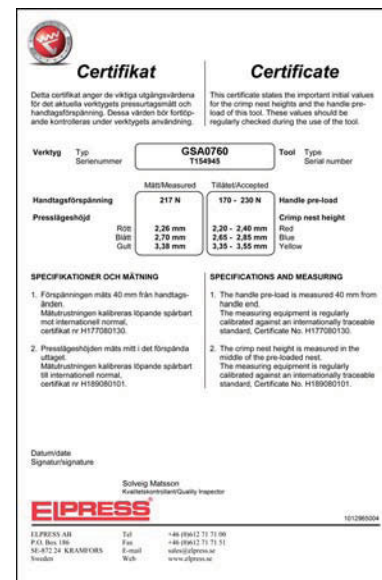

Elpress certificate.





Ring terminals 0.1 - 6 mm²

■ Data: Cu 99.95%, tin plated, brazed necks.

■ PC sleeves have EasyEntry, PC and PA sleeves are halogen free.

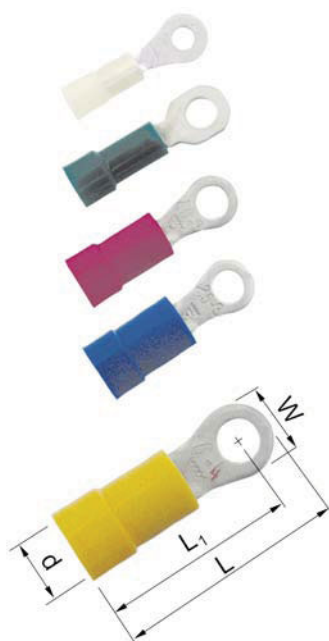

	mm ²	Cat. no.	Screw	mm W	d	t	L ₁	L	s	Rec. tool	Pcs/pack	Insulation
Yellow	0,1-0,5	A0522R	M2	5,4	2,0	0,5	14,0	16,0	6	DSA0115	100	PA*
		A0532R	M3	5,0	2,0	0,5	14,0	16,0	6	DSA0115	100	PA*
		A0543R	M4	7,0	2,0	0,5	16,0	19,0	6	DSA0115	100	PA*
		A0553R	M5	8,0	2,0	0,5	15,0	19,0	6	DSA0115	100	PA*
Green	0,25-0,75	A0832R	M3	5,5	3,2	0,5	15,0	18,0	7	DSA0115	100	PC
		A0837R	M3,5	6,2	3,2	0,5	17,5	21	7	DSA0115	100	PC
		A0843R	M4	7,5	3,2	0,5	17,5	21	7	DSA0115	100	PC
		A0853R	M5	9	3,2	0,5	17,5	22	7	DSA0115	100	PC
Red	0,5-15	A1532R	M3	5,5	4,0	0,7	16,0	19,0	7	GSA0760	100	PC
		A1537R	M3,5	6,0	4,0	0,7	16	19	7	GSA0760	100	PC
		A1543R	M4	7,5	4,0	0,7	17	20,5	7	GSA0760	100	PC
		A1553R	M5	9,0	4,0	0,7	18	22,5	7	GSA0760	100	PC
		A1565R	M6	11,0	4,0	0,7	21	26,5	7	GSA0760	100	PC
		A1585R	M8	14,0	4,0	0,7	20	27,5	7	GSA0760	100	PC
		A1510R	M10	16,5	4,0	0,7	22	30,5	7	GSA0760	100	PC
Blue	1,5-2,5	A2532R	M3	5,5	4,5	0,8	16	19	8	GSA0760	100	PC
		A2537R	M3,5	6	4,5	0,8	16	19	8	GSA0760	100	PC
		A2543R	M4	7	4,5	0,8	17,5	21	8	GSA0760	100	PC
		A2553R	M5	9,0	4,5	0,8	18	23	8	GSA0760	100	PC
		A2565R	M6	11,0	4,5	0,8	20,6	26,1	8	GSA0760	100	PC
		A2585R	M8	14,0	4,5	0,8	20	27,5	8	GSA0760	100	PC
		A2510R	M10	16,5	4,5	0,75	22	30,5	8	GSA0760	100	PC
		A2513R	M12	19,0	4,5	0,75	25	34	8	GSA0760	100	PA
Yellow	4-6	A4643R	M4	7,8	6,4	1,0	20,5	24,5	9	GSA0760	100	PC
		A4653R	M5	9,0	6,4	1,0	20,5	25	9	GSA0760	100	PC
		A4665R	M6	11,0	6,4	1,0	23	28,5	9	GSA0760	100	PC
		A4685R	M8	14,0	6,4	1,0	23,8	30,8	9	GSA0760	100	PC
		A4610R	M10	17,0	6,4	1,0	25,5	34	9	GSA0760	50	PC
		A4613R	M12	19,2	6,8	1,0	31	40	9	GSA0760	50	PVC*

t = palm thickness s = strip length * no EasyEntry

For detailed information regarding recommended tool, see tool section at the end of this chapter.



Fork terminals 0.1 - 6 mm²

■ Data: Cu 99.95%, tin plated, brazed necks.

■ PC sleeves have EasyEntry, PC and PA sleeves are halogen free.

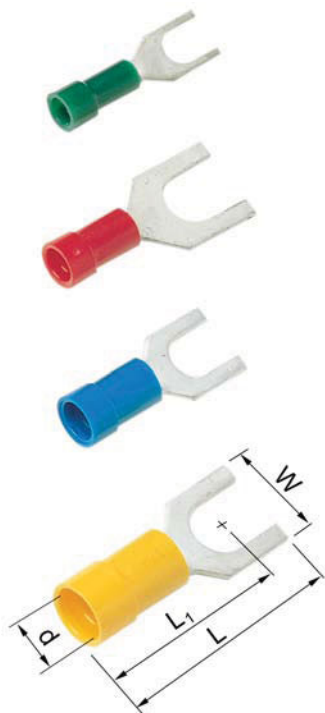

	mm ²	Cat. no.	Screw	mm W	d	t	L ₁	L	s	Rec. tool	Pcs/ pack	Insulation	
Green	0,1-0,5	A0532G	M3	5,0	2,0	0,5	14,0	16,0	6	DSA0115	100	PA*	
		0,25-0,75	A0832G	M3	5,5	3,2	0,5	15,0	18,0	7	DSA0115	100	PC
			A0837G	M3,5	6,2	3,2	0,5	17,5	21	7	DSA0115	100	PC
A0843G	M4	6,2	3,2	0,5	17,5	21	7	DSA0115	100	PC			
Red	0,5-1,5	A1532G	M3	5,5	4,0	0,7	16	19	7	GSA0760	100	PC	
		A1537G	M3,5	6,2	4,0	0,7	17,5	21	7	GSA0760	100	PC	
		A1537GS	M3,5	5,5	4,0	0,7	17	21,2	7	GSA0760	100	PC	
		A1543G	M4	7,0	4,0	0,7	17,5	21	7	GSA0760	100	PC	
		A1553G	M5	9,0	4,0	0,7	18	22,5	7	GSA0760	100	PC	
		A1565G	M6	11,0	4,0	0,7	21	26,5	7	GSA0760	100	PC	
Blue	1,5-2,5	A2532G	M3	5,5	4,5	0,8	15,0	18,0	8	GSA0760	100	PC	
		A2537G	M3,5	6,2	4,5	0,8	17,5	21	8	GSA0760	100	PC	
		A2537GS	M3,5	5,5	4,5	0,8	17	21,2	8	GSA0760	100	PC	
		A2543G	M4	7,0	4,5	0,8	17,5	21	8	GSA0760	100	PC	
		A2553G	M5	9,0	4,5	0,8	18	23	8	GSA0760	100	PC	
		A2565G	M6	11,0	4,5	0,8	19,5	25	8	GSA0760	100	PC	
Yellow	4-6	A4643G	M4	7,8	6,4	1,0	20	24	9	GSA0760	100	PC	
		A4653G	M5	9,0	6,4	1,0	20,5	25	9	GSA0760	100	PC	
		A4665G	M6	11,0	6,4	1,0	21,5	27	9	GSA0760	100	PC	
		A4685G	M8	14,0	6,4	1,0	23	30	9	GSA0760	100	PC	
		A4610G	M10	18,0	6,4	1,0	27	36	9	GSA0760	100	PA	

t = palm thickness s = strip length * no EasyEntry

Flanged fork terminals 0.5 - 2.5 mm²

■ Data: Cu 99.95%, tin plated, brazed necks.

■ PC sleeves have EasyEntry, PC and PA sleeves are halogen free.

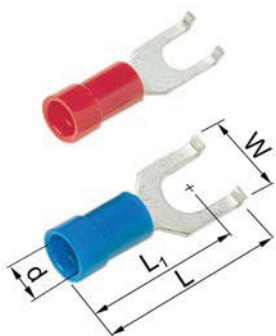

	mm ²	Cat. no.	Screw	mm W	d	t	L ₁	L	s	Rec. tool	Pcs/ pack	Insulation
Red	0,5-1,5	A1537GB	M3,5	6,2	4,0	0,7	17,5	21	7	GSA0760	100	PC
		A1543GB	M4	6,2	4,0	0,7	17,5	21	7	GSA0760	100	PC
Blue	1,5-2,5	A2543GB	M4	6,2	4,5	0,8	17,5	21	7	GSA0760	100	PC
		A2553GB	M5	9,0	4,5	0,8	17,5	22,5	7	GSA0760	100	PC

t = palm thickness s = strip length

Hook terminals 0.5 - 2.5 mm²

■ Data: Cu 99.95%, tin plated, brazed necks.

■ PC sleeves have EasyEntry, PC and PA sleeves are halogen free.

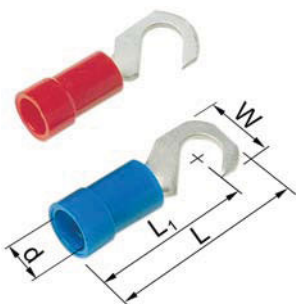

	mm ²	Cat. no.	Screw	mm W	d	t	L ₁	L	s	Rec. tool	Pcs/ pack	Insulation
Red	0,5-1,5	A1543K	M4	7	4,0	0,8	17	20,5	7	GSA0760	100	PC
Blue	1,5-2,5	A2543K	M4	7,5	4,5	0,8	17	21	8	GSA0760	100	PC

t = palm thickness s = strip length

For detailed information regarding recommended tool, see tool section at the end of this chapter.



Pin terminals 0.1 - 6 mm²

■ Data: Cu 99.95%, tin plated, brazed necks.

■ PC sleeves have EasyEntry, PC and PA sleeves are halogen free.

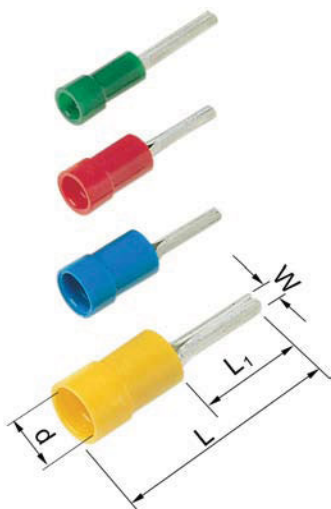

mm ²	Cat. no.	mm W	d	L ₁	L	s	Pcs/ pack	Rec. tool	Insulation
0,1-0,5	A0514SR	1,4	2,0	8,0	18,0	6	100	DSA0115	PA*
0,25-0,75	A0819SR	1,8	3,2	12,0	22	7	100	DSA0115	PC
	A0819SRK	1,8	3,2	8,5	18,5	7	100	DSA0115	PC
0,5-1,5	A1519SR	1,7	4,0	12,0	22	7	100	GSA0760	PC
	A1519SRK	1,7	4,0	8,5	18,5	7	100	GSA0760	PC
1,5-2,5	A2519SR	1,9	4,5	11,5	21,5	8	100	GSA0760	PC
	A2519SRK	1,9	4,5	8,5	18,5	8	100	GSA0760	PC
4-6	A4630SR	2,7	6,4	14,0	27	9	100	GSA0760	PC

s = strip length * no EasyEntry

Blade terminals 0.25 - 6 mm²

■ Data: Cu 99.95%, tin plated, brazed necks.

■ PC sleeves have EasyEntry, PC and PA sleeves are halogen free.

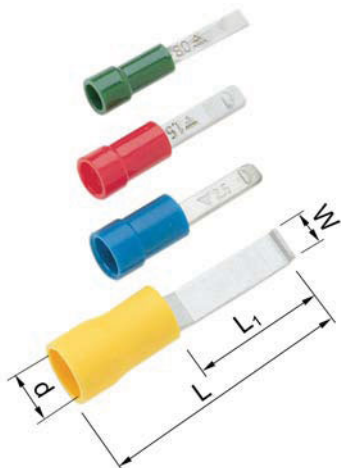

mm ²	Cat. no.	mm W	d	t	L ₁	L	s	Pcs/ pack	Rec. tool	Insulation
0,25-0,75	A0825SFK	2,5	3,2	0,5	10,0	20	7	100	DSA0115	PC
0,5-1,5	A1518SFL	2,3	4,6	0,8	18,0	27	7	100	GSA0760	PVC
	A1529SF	2,9	4,0	0,7	12,0	22	7	100	GSA0760	PC
	A1529SFN	2,9	4	0,7	12	22	7	100	GSA0760	PC**
	A1530SFB	3,0	4,5	0,8	17,5	27	7	100	GSA0760	PVC
1,5-2,5	A2524SFL	2,4	4,5	0,8	18,0	28	8	100	GSA0760	PVC
	A2529SF	2,9	4,3	0,7	11,5	21,5	8	100	GSA0760	PC
	A2529SFN	2,9	4,3	0,7	12	22	8	100	GSA0760	PC**
	A2530SFB	3	4,6	0,7	17,5	27	8	100	GSA0760	PVC
4-6	A4640SF	4	6,7	1,0	13,0	27	9	100	GSA0760	PVC*
	A4645SFB	4,5	6,7	1,0	17,5	32	9	100	GSA0760	PVC*

t = palm thickness s = strip length * no EasyEntry ** with tab

Through connectors 0.25 - 6 mm²

■ Data: Cu 99.95%, tin plated.

■ Insulation sleeves are halogen free, no EasyEntry.



mm ²	Cat. no.	mm d	L	s	Pcs/ pack	Rec. tool	Insulation
0,25-0,75	A0824SK	2,9	24,5	7	100	DSA0115	PC
0,5-1,5	A1525SK	3,4	24	7	100	GSA0760	PC
1,5-2,5	A2527SK	4,3	26	8	100	GSA0760	PC
4-6	A4652SK	6,5	33	9	50	GSA0760	PC

s = strip length

For detailed information regarding recommended tool, see tool section at the end of this chapter.

**Through connectors with heat shrink insulation 0.5 - 6 mm²**

■ Data: Cu 99.95%, tin plated, heat shrink sleeve with melting glue inside.

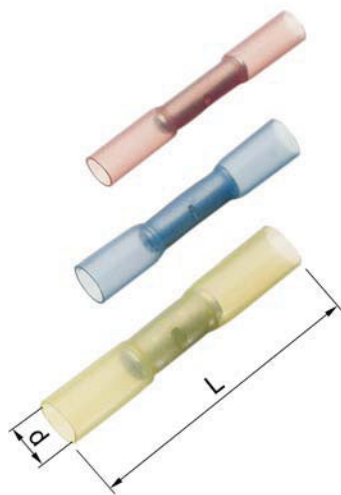

	mm ²	Cat. no.	mm d	L	s	Pcs/pack	Rec. tool	Insulation
■	0,5-1,5	A1535SKW	4,5	35	8	25	GSW0560C	PA
■	1,5-2,5	A2535SKW	5,4	35	8	25	GSW0560C	PA
■	4-6	A4650SKW	6,8	40	9	25	GSW0560C	PA

s = strip length

After crimping and hot air gun heating, a water proof connection, glued to the cable and the connector, is achieved.

Parallel connectors 0.5 - 6 mm²

■ Data: Cu 99.95%, tin plated.

■ Insulation sleeves are halogen free.



	mm ² Total	Cat. no.	mm d	L	s	Pcs/pack	Rec. tool	Insulation
■	0,5-1,5	A1515PSK	3,2	17,0	7	100	GSA0760	PA
■	1,5-2,5	A2517PSK	4	17,0	8	100	GSA0760	PA
■	4-6	A4634PSK	5,6	21	9	100	GSA0760	PA

s = strip length

Type PSK must be crimped with GSA0760 (C) and with two crimps.

For detailed information regarding recommended tool, see tool section at the end of this chapter.



Receptacles 0.1 - 6 mm²

■ Data: brass or tin bronze, tin plated, brazed necks.

■ PC sleeves have EasyEntry, PC and PA sleeves are halogen free.



	mm ²	Cat. no.	mm d	L	For tabs	s	Pcs/pack	Rec. tool	Insulation
Yellow	0,1-0,5	A0503FLS5	2,3	16,0	2,8x0,5	7	100	DSA0115	PVC*
		A0503FLS8	2,3	16,0	2,8x0,8	7	100	DSA0115	PVC*
Red	0,5-1,5	A1503FLS5	3,3	18,5	2,8x0,5	7	100	GSA0760	PC
		A1503FLS8	3,3	18,5	2,8x0,8	7	100	GSA0760	PC
		A1505FLS5	3,7	19,0	4,8x0,5	7	100	GSA0760	PVC
		A1505FLS8	3,7	19,0	4,8x0,8	7	100	GSA0760	PVC
		A1507FLS	4,0	20	6,3x0,8	7	100	GSA0760	PC
		A1507FLST	4,0	20	6,3x0,8	7	100	GSA0760	PC**
Blue	1,5-2,5	A2505FLS5	4,4	19,0	4,8x0,5	8	100	GSA0760	PVC
		A2505FLS8	4,4	19,0	4,8x0,8	8	100	GSA0760	PVC
		A2507FLS	4,5	20	6,3x0,8	8	100	GSA0760	PC
		A2507FLST	4,5	20	6,3x0,8	8	100	GSA0760	PC**
		A2508FLS	4,3	24	8,4x0,8	8	100	GSA0760	PVC***
Yellow	4-6	A4607FLS	6,4	24	6,3x0,8	9	100	GSA0760	PC
		A4609FLS	6,2	31	9,5x1,2	9	100	GSA0760	PVC***

s = strip length * no EasyEntry ** made from tin-bronze (phosphorus bronze)

*** not brazed, reinforcement sleeve, no EasyEntry.

Multiple tabs 0.5 - 2.5 mm²

■ Data: brass, tin plated, no EasyEntry.



	mm ²	Cat. no.	mm d	L	For tabs	s	Pcs/pack	Rec. tool	Insulation
Red	0,5-1,5	A1507FLSH	3,7	22	6,3x0,8	7	100	GSA0760	PVC*
Blue	1,5-2,5	A2507FLSH	4,3	22	6,3x0,8	8	100	GSA0760	PVC*

s = strip length * non-brazed with reinforcement sleeve

For detailed information regarding recommended tool, see tool section at the end of this chapter.



Receptacles, fully insulated 0.5 - 6 mm²

■ Data: brass, tin plated, brazed necks.

■ PC sleeves have EasyEntry, PC and PA sleeves are halogen free.



	mm ²	Cat. no.	mm d	L	For tab	s	Pcs/ pack	Rec. tool	Insulation
■	0,5-1,5	A1503FLSF5	3,8	19,3	2,8x0,5	7	100	GSA0760	PA*
		A1503FLSF8	3,8	19,3	2,8x0,8	7	100	GSA0760	PA*
		A1505FLSF5	3,6	20,2	4,8x0,5	7	100	GSA0760	PA*
		A1505FLSF8	3,6	20,2	4,8x0,8	7	100	GSA0760	PA*
		A1507FLSF	4,0	21	6,3x0,8	7	100	GSA0760	PC
■	1,5-2,5	A2505FLSF5	3,9	19,5	4,8x0,5	8	100	GSA0760	PA*
		A2505FLSF8	3,9	19,5	4,8x0,8	8	100	GSA0760	PA*
		A2507FLSF	4,5	21	6,3x0,8	8	100	GSA0760	PC
■	4-6	A4607FLSF	5,3	26	6,3x0,8	9	100	GSA0760	PA*

s = strip length * non-brazed with reinforcement sleeve, no EasyEntry

Tabs 0.5 - 6 mm²

■ Data: brass, tin plated, brazed necks.

■ PC sleeves have EasyEntry, PC and PA sleeves are halogen free.

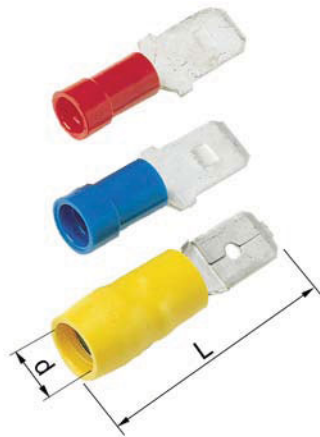

	mm ²	Cat.no.	mm d	L	For receptacles	s	Pcs/ pack	Rec. tool	Insulation
■	0,5-1,5	A1507H	4,0	22	6,3x0,8	7	100	GSA0760	PC
■	1,5-2,5	A2507H	4,5	22	6,3x0,8	8	100	GSA0760	PC
■	4-6	A4607H	6,3	25	6,3x0,8	9	100	GSA0760	PVC*

s = strip length * non-brazed with reinforcement sleeve, no EasyEntry.

End connectors, fully insulated, 1 - 6 mm²

■ Data: Copper tube, tin plated.

■ Insulation sleeves are halogen free, PA. EasyEntry.



	mm ²	Cat. no.	mm d	L ₁	L	s	Pcs/ pack	Rec. tool	Insulation
	1-3	A2500E	6,4	8,0	15,2	8	100	GSA0760	PA
	4-6	A4600E	9,2	9,0	17,7	9	100	GSA0760	PA

s = strip length

For detailed information regarding recommended tool, see tool section at the end of this chapter.



Bullets 0.25 - 6 mm²

■ Data: brass/Cu, tin plated.

■ PC sleeves have EasyEntry, PC and PA sleeves are halogen free.



mm ²	Cat. no.	mm d	L	Diameter	s	Pcs/ pack	Rec. tool	Insulation
0,25-0,75	A0802HA	3,6	26	2,0	7	100	DSA0115	PA*
0,5-1,5	A1504HA	4,0	22	4,0	7	100	GSA0760	PC
1,5-2,5	A2505HA	4,3	20	5,0	8	100	GSA0760	PVC*
4-6	A4605HA	6,6	26	5,0	9	100	GSA0760	PA*

s = strip length * non-brazed with reinforcement sleeve, no EasyEntry.

Sockets, fully insulated 0.25 - 6 mm²

■ Data: brass/tin bronze/Cu, tin plated.

■ PC sleeves have EasyEntry, PC and PA sleeves are halogen free.



mm ²	Cat. no.	mm d	L	For bullets diam.	s	Pcs/ pack	Rec. tool	Insulation
0,25-0,75	A0802HO	3,4	24	2,0	7	100	DSA0115	PA*
0,5-1,5	A1504HO	4,0	25	4,0	7	100	GSA0760	PC**
1,5-2,5	A2505HO	4,3	26	5,0	8	100	GSA0760	PVC*
4-6	A4605HO	5,7	27	5,0	9	100	GSA0760	PA*

s = strip length * non-brazed with reinforcement sleeve

** made from tin bronze (phosphorous bronze), EasyEntry

For detailed information regarding recommended tool, see tool section at the end of this chapter.



Assortment boxes

PL1001

Elpress assortment box designed for electromechanical shops and service departments.



- strong polypropylene box
- 29 partitions
- 1000 pre-insulated terminals 0,5 - 6 mm²
- connector blocks
- crimping tool GSA0760 Miniforce
- stripping and cutting tool STC001
- weight 3.9 kg
- length 370 mm, width 298 mm, height 37 mm

PL451M

Elpress assortment box designed for various professional use.



- manufactured from polypropylene
- 11 partitions
- 350 pre-insulated terminals 0,5 - 6 mm²
- 2 connector blocks
- crimping tool GSA0760 Miniforce
- stripping and cutting tool SCT001
- weight 1.5 kg
- length 246 mm, width 218 mm, height 57 mm



PL450

Elpress assortment box designed for hobby use.

- manufactured from polypropylene
- 11 partitions
- 350 pre-insulated terminals 0,5 - 6 mm²
- 2 connector blocks
- hobby crimping tool T50 which crimps, cuts and strips up to 6 mm² and cuts screws M2,5 - M5.
- weight 1,1 kg
- length 246 mm, width 218 mm, height 57 mm



HB150

Elpress assortment box designed for hobby use.

- polypropylene box
- 11 partitions
- 150 pre-insulated terminals 0.5 - 6 mm²
- 2 connector blocks
- hobby crimping tool T50 which crimps, cuts and strips up to 6 mm² and cuts screws M2.5 - M5
- weight 0.80 kg
- length 246 mm, width 218 mm, height 57 mm





Hobby tools for crimping terminals 0.5 - 6 mm² and for cutting and stripping

Technical data:

- manufactured from high-class steel and with semi-soft handles
- die nests are distinctly marked
- no full closure ratchet
- cuts up to 6 mm²
- strips up to 6 mm²
- bolt-cutter M2,5 - M5
- weight 0.20 kg, length 225 mm

Crimp range 0.5 - 6 mm²

T50

Elpress hobby tool.

Particulars:

- crimps pre-insulated terminals 0.5 - 6 mm² and indent crimps un-insulated, closed barrel terminals 1.5 - 6 mm²
- red, semi-soft handles for optimal comfort
- stripping and bolt cutting functions

T50



Crimp types

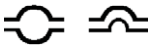

Area	Cat. no.	Crimp type	Weight	Length
0.5-6 mm ²	T50	oval/indent	0.200 kg	225 mm

T51

Elpress hobby tool.

Particulars:

- crimps pre-insulated terminals 0.5 - 6 mm², and roll crimps open barrel un-insulated terminals 0.5 - 2.5 mm²
- yellow, semi-soft handles for optimal comfort
- stripping and bolt cutting functions

T51



Crimp types

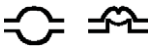

Area	Cat. no.	Crimp type	Weight	Length
0.5-6 mm ²	T51	oval/roll	0.200 kg	225 mm

T52

Elpress hobby tool.

Particulars:

- roll crimps un-insulated, open barrel, un-insulated terminals 0.5 - 6 mm²
- green, semi-soft handles for optimal comfort
- stripping and bolt cutting functions

T52



Crimp type



Area	Cat. no.	Crimp type	Weight	Length
0.5-6 mm ²	T52	roll	0.200 kg	225 mm



Certified crimp tools for pre-insulated terminals 0.14 - 2.5 mm²



Technical data:

- die nests are distinctly laser marked
- adjustable if changes occur, ie after many crimps
- tested with Elpress terminals
- ratchet system which guarantees a fully closed crimp
- emergency release if the crimp sequence must be interrupted
- unique design makes the tools compact and handy
- requires minimum of muscle force for a perfect crimp
- designed to fit both right- and left-handed users
- at least 50.000 crimps
- delivered with certificate for quality assurance

Crimp range 0.14 - 1.5 mm²

DSA0115

Elpress crimp tool for symmetrical crimping of pre-insulated terminals.

Area	Cat. no.	Crimp type	Weight	Length x Width
0.14-1.5 mm ²	DSA0115	oval, symmetrical	0.445 kg	192 x 66 mm

DSA0115



Crimp type



Crimp range 0.5 - 2.5 mm²

DSA0725

Elpress crimp tool for symmetrical crimping of pre-insulated terminals.

Particulars:

- die nest wear inspection easily made with go/no-go gauge ESAQ 0760

Area	Cat. no.	Crimp type	Weight	Length x Width
0.5-2.5 mm ²	DSA0725	oval, symmetrical	0.449 kg	192 x 66 mm

DSA0725



Crimp type





ESAQ 0760 - die nest gauge

Elpress go/no-go gauge for inspection of die nests in the following crimp tools: DSA0115, DSA0725, GSA0760(C) and GSEA0340C.

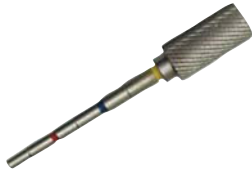













Particulars:

- grip Ø 8 mm
- supplied in practical plastic box
- a simple means to secure proper tool performance
- easy to use, with a GO-position and a NO GO-position for each die nest of the crimp tool.

Please contact Elpress for more information on tool calibration and QA.

Area	Cat. no.	Weight	Length
0.5-2.5 mm ²	ESAQ 0760 -tolk	0.250 kg	55 mm

Tool	Checks die nest
DSA0115	  
DSA0725	  
GSA0760(C)	  
GSEA0340C	  



Certified Miniforce tools for pre-insulated terminals 0.5 - 6 mm² and end terminals 0.25 - 4 mm²



Technical data:

- unique mechanism that reduces maximum handle force with 30% compared to the earlier Exx version
- ratchet system to guarantee a fully closed crimp
- release mechanism if the crimping sequence must be interrupted
- symmetrical and distinctly laser marked die nests
- adjustable if changes occur, ie after many crimps
- tested with Elpress terminals
- ergonomically designed handles to fit all users
- optimises the quality of the crimp result
- reduces the risk for repetitive strain injuries (RSI)
- light and handy design without reduction in durability
- type C has extra long handles for two hand grip
- at least 80 000 crimps
- delivered with certificate for quality assurance

Crimp range 0.25 - 4 mm²

GSEA0340C

Miniforce **combination crimp tool** for crimping of both;

- pre-insulated terminals 0.5 - 2.5 mm² and
- pre-insulated and un-insulated end terminals 0.25 - 4 mm²

Area	Cat. no.	Crimp types	Weight	Length x Width
0.25-4 mm ²	GSEA0340C	oval, symmetrical, trapezoid	0.682 kg	255 x 72 mm

GSEA0340C



Crimp types



Crimp range 0.5 - 6 mm²

GSW0560C

Miniforce crimp tool for through connectors with **heat shrink insulation** type SKW. Dies nest specially designed for crimping of the through connectors with heat shrink insulation – know as the SKW type. Use of other tools will destroy/harm the insulation leaving un-insulated openings direct to the terminal.

Area	Cat. no.	Crimp types	Weight	Length x Width
0.5-6 mm ²	GSW0560C	oval, symmetrical	0.678 kg	255 x 72 mm

GSW0560C



Crimp type





GSA0760 and GSA0760C

Elpress Miniforce crimp tools for symmetrical crimping of pre-insulated terminals 0,5 - 6 mm².

GSA0760



GSA0760C



Particulars:

- locator to hold the terminal in the right position when crimping which simplifies the installation
- die calibration is easily performed with the gauge ESAQ0760
- die nests leave imprints on terminal insulation sleeve after crimp to show nest size and Elpress logotype for system identification

Area	Cat. no.	Crimp types	Weight	Length x Width
0.5-6 mm ²	GSA0760	oval, symmetrical	0.664 kg	220 x 72 mm
0.5-6 mm ²	GSA0760C	oval, symmetrical	0.678 kg	255 x 72 mm

Crimp type



GSA0760 locator

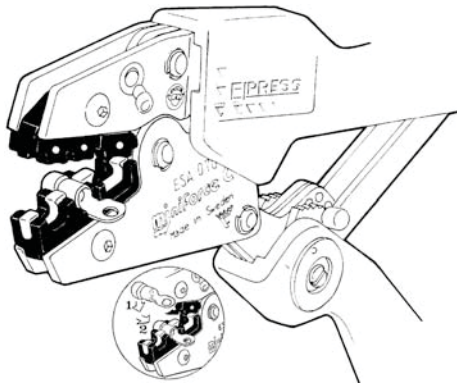

Follow the sequence (1) and (2) when placing the terminals into the locator.



Elpress Mobile - a tool with interchangeable dies



Professional crimp tool with interchangeable dies for electrical installations and data-com.

Technical data:

- a reliable, safe, economical and comfortable tool
- parallel-action stroke with a maximum force of 10 000 N, tested for 20000 crimps
- easily interchangeable crimp dies with one handgrip
- the dies are kept together as pairs with a special rod to simplify handling
- a wide range of crimping dies enables the user to cover 20-30 applications in just one tool frame

You purchase Elpress Mobile in four basic versions:

Elpress Mobile

Mobile handtool (only the frame). Dies supplemented.

Cat. no.	Weight	Length x Width
Elpress Mobile	0.554 kg	234 x 64 mm



Mobile, only the frame.

Mobile Installation

Mobile hand tool and two interchangeable dies:

- die OAA0525 for crimping of insulated terminals 0.5 - 2.5 mm²
- die OEB0210 for crimping of end sleeves 0.25 - 10 mm²
- the tool is delivered with dies in a plastic packaging

Cat. no.	Weight	Length x Width
Mobile Installation	0.694 kg	234 x 64 mm



Mobile + dies OAA0525 and OEB0210.



Mobile DataCom

Mobile hand tool and two interchangeable dies:

- die OMP45 for crimping of modular plug, RJ45 contacts
- die OCC1113 for crimping of coaxial contacts RG58, 59, 62, 71
- the tool is delivered with dies in a plastic packaging



Mobile + dies OMP45 and OCC1113.

Cat. no.	Weight	Length x Width
Mobile DataCom	0.659 kg	234 x 64 mm

Mobile Solar Kit

Mobile hand tool for Solar panel installations including tool, three interchangeable dies and cable stripper LOKE for solar panel cable with extra thick insulation.

- OMS4, for crimping of Solar type connectors \varnothing 4 mm, with open barrel conductor crimp 2.5 - 6.0 mm²
- OMS3, for crimping of Solar connectors \varnothing 3 mm, turned pin type 2.5 - 6.0 mm²
- OMSL, for crimping of Solar connectors, turned pin type, Solar Lock 2.5 - 6.0 mm²



Mobile + dies OMS4, OMS3 and OMSL

Cat. no.	Weight	Length x Width
Mobile Solar Kit	0.722 kg	234 x 64 mm



Cable stripper LOKE.

Mobile Box

Box for the Mobile tool which has place for the tool and 5-6 dies. The Mobile tool and dies are ordered separately.

Cat. no.	Weight	Length x Width	Height
Mobile Box	0.320 kg	246 x 218 mm	56.5 mm



Additional dies to Elpress Mobile are presented in the table on the following page.



You complete your kit with these dies

Additional dies to Elpress Mobile. All dies have the same easy and fast fastening in the frame. The dies are kept together as pairs and delivered in a plastic cassette which can be put together with other cassettes.



OAA0160
For crimping of pre-insulated terminals 0.1 - 0.5 & 4 - 6 mm².



OAA0525
For crimping of pre-insulated terminals 0.5 - 2.5mm².



OSW0360
For crimping of through connectors with heat shrink insulation 0.3-0.75 and 4-6 mm²



OSW0525
For crimping of through connectors with heat shrink insulation 0.5-1.5 and 1.5-2.5 mm²



OPB0140
For crimping of global power connectors, GPC.



OPB6099
For crimping of global power connectors, GPC.



OWB4099
For W-crimping of un-insulated terminals 4 - 10 mm².



OKB0725
For indent crimping of un-insulated terminals 0.75 - 2.5 mm².



OKB0560
For indent crimping of un-insulated terminals 0.5 - 6 mm².



OEB0210
For crimping of end terminals 0.25 - 10 mm².



OEB1625
For crimping of end terminals 16 - 25 mm².



OEB3550
For crimping of end terminals 35 - 50 mm².



ORB0110
For roll crimping of terminals 0.1 - 1.0 mm².



ORB0560
For roll crimping of terminals 0.5 - 6 mm².



OMP45
For crimping of modular-plug RJ45.



OMP11
For crimping of modular-plug RJ11.



OFO5432
For crimping of fiber optics connections type ST, SC, SMA, SMB, SFR.



OCC0908
For crimping of coaxial contacts type BNC, TNC, RG174, RG179.



OCC1113
For crimping of coaxial contacts type BNC, TNC, RG58, RG59, RG62, RG71.



OCC4755
For crimping of coaxial contacts type CATV, RG6, RG59.



OMS4
For crimping of solar connectors Ø 4 mm, with open barrel conductor crimp 2.5 - 6.0 mm².



OMS3
For crimping of solar connectors Ø 3 mm, turned pin type 2.5 - 6.0 mm².



OMSL
For crimping of solar connectors turned pin type Solar Lock 2.5 - 6.0 mm².





Battery powered crimp tool



PV130P, PV130S - Elpress Mini.

Technical data:

- NiMh battery power (9.6 V and 1.3 Ah), recharge time approx. 40 minutes
- advanced ergonomics for excellent access in confined areas
- tool for service and installation work
- fast crimping 2-4 seconds
- approx. 150 crimps per charge
- crimp ranges see table below
- supplied in a plastic case with battery charger and one battery

Crimp range 0.5-6, 0.25-10, 0.5-50 mm²

PV130P - Elpress Mini

Battery powered tool for parallel action crimping of pre-insulated terminals up to 6 mm², un-insulated terminals up to 10 mm² and end terminals up to 50 mm².

Included:

- Battery: PVBP1-MH
- Charger: PVBC2

Area	Cat. no.	Weight	Length
0.5-6/0.25-10/0.5-50 mm ²	PV130P - Elpress Mini	1.3 kg	360 mm



PV130P, box and charger.

PV130S - Elpress Mini

Battery powered tool for scissor crimping movement of pre-insulated terminals up to 6 mm², un-insulated terminals up to 10 mm² and end terminals up to 50 mm².

Included:

- Battery: PVBP1-MH
- Charger: PVBC2

Area	Cat. no.	Weight	Length
0.5-6/0.25-10/0.5-50 mm ²	PV130S - Elpress Mini	1.5 kg	360 mm



RB0560

Die table

	PV130P	PV130S
Application	Die	Die
Pre-insulated 0.5-6 mm ²	SA0760	SA0760
Un-insulated, indent crimp 0.25-2.5 mm ²	KB0325	KB0325
Un-insulated, W crimp 4-10 mm ²	WB4099	WB4099
Un-insulated, roll-crimp 0.5-6 mm ²	RB0560	RB0560
End terminals (ferrules)		
0.5-6 mm ²	EB0560	EB0560
4-10 mm ²	EB4010	EB4010
10-25 mm ²	EB1025	EB1025
35-50 mm ²	EB3550	EB3550

Remember to specify dies when you order a tool.



Notes



End terminals (ferrules) and tools

General information about end terminals	2
Hand tools for end terminals (ferrules)	3
Pre-insulated end terminals 0.14 - 50 mm ² ET, standard colour	4
Pre-insulated end terminals 0.14 - 50 mm ² ETT, alternative colour	5
Pre-insulated end terminals 0.14 - 50 mm ² ETD, alternative colour	6
Pre-insulated end terminals for short-circuit proof cable-insulations 1.5 - 16 mm ²	7
Un-insulated end terminals 0.25 - 50 mm ²	8
Pre-insulated TWIN end terminals 2x0.5 - 2x10 mm ² , ET2	10
Pre-insulated TWIN end terminals 2x0.5 - 2x10 mm ² , ETT2	11
Pre-insulated TWIN end terminals 2x0.5 - 2x10 mm ² , ETW2	11
Assortment boxes	12
Certified Miniforce tools for end terminals 0.25 - 4 mm ²	13
Certified crimp tools for end terminals (ferrules) 0.25 - 16 mm ²	14
Certified Miniforce tools for end terminals (ferrules) 0.1 - 6 mm ² and TWIN end terminals 2x0.5 - 2x10 mm ²	16
Certified Miniforce tools for end terminals 4 - 50 mm ²	18
Elpress Mobile - a tool with interchangeable dies	20
Battery powered crimp tool	23



General information about end terminals

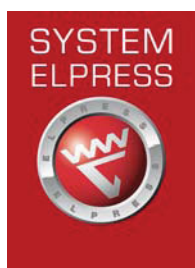

System Elpress

System Elpress consists of connectors and tools tested together for optimum connection result. The System concept makes you as a customer able to feel secure when using our system and to be sure a safe connection is made when Elpress products are used correctly. When using the appropriate Elpress ratchet crimp tools a connection with approval to VDE 0609 is achieved.

End terminals

Elpress pre-insulated and un-insulated end terminals are manufactured from tin plated, electrolytic 99.95% copper tubes. The end terminals have dimensions in accordance with DIN 46228 (with a few exceptions, see tables). The pre-insulated sleeves are made of Polypropylene/PP, and have a conical EasyEntry, inside shape. Elpress end terminals are used

when a perfect connection is required, for example, to a screw terminal block. The strands are kept together and connecting screws will not damage the strands. Long lasting contact forces are easier to achieve.

In addition to the pre-insulated end terminals shown in the tables, we also offer similar terminals with other commonly used colour coding systems as well as terminals above 50 mm² when needed.

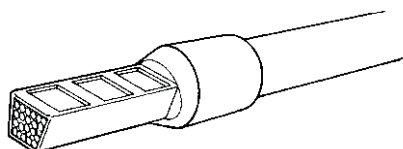

Crimped pre-insulated end terminal.

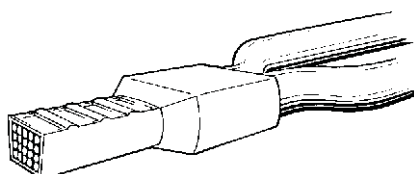

Crimped TWIN end terminal.

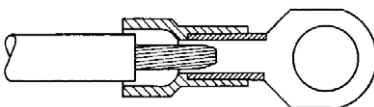

EasyEntry.

Product designations

Cat. no. A4-12ET (example)	
A	= pre-insulated
B	= un-insulated
4	= cross section area (4 mm ²)
12	= metal sleeve length
ET	= end terminal
ET2	= TWIN end terminal



CSA certification

CSA, Canadian Standards Association, is a Canadian organization that certifies products according to American standards.

Elpress end terminals of the type A..ET/ETT/ETD, B...ET, A...ET2/ETT2/ETW2 is CSA certified according to the American Standards C22.2 No. 158 and UL 1059 under file No. 247206. End terminals of the type A..ET/B...ET/A...ET2 is for use with stranded Cu-conductors 26 AWG to 500 MCM, corresponding to the metric size of 0.14 mm² to 240 mm². For use with Elpress professional crimping tools.

Colour codes for pre-insulated end terminals and TWIN end terminals

Cross section area, mm ²	Colours as per DIN 46228 Elpress type ET2 TWIN	Elpress standard colour W type ET	Elpress alternative colour T type ETT
0,14	grey	grey	brown
0,25	yellow	light blue	violet
0,34	turquoise	turquoise	pink
0,50	white	red-orange	white
0,75	grey	white	blue
1	red	yellow	red
1,5	black	red	black
2,5	blue	blue	grey
4	grey	grey	orange
6	yellow	black	green
10	red	ivory	brown
16	blue	green	white
25	yellow	brown	black
35	red	beige	red
50	blue	olive green	blue
70	yellow	yellow	yellow
95	red	red	red
120	blue	blue	blue
150	yellow	yellow	yellow



Hand tools for end terminals (ferrules)

Mechanical hand tools

High quality, crimp performance and ergonomics are prime considerations of Elpress when developing mechanical crimp tools. Except for the hobby tools, all Elpress crimp tools have a full closure, ratchet mechanism to ensure correct crimps at all instances - a prerequisite for professional and quality assured work.



Elpress Mobile, a professional crimp tool with interchangeable dies.

Miniforce tool

With the unique Miniforce range of crimp tools, a new level of performance was established when speaking of ergonomic adaption to the user and of low handle forces needed. A reduction of required force up to 45% is reached as a result of advanced ergonomic studies where minimised risk for work discomfort or even injuries was the main objective.



Miniforce type C has extra long handles for an easy two-hand grip which in most

cases represents a simple and natural way of lowering work loads.

Elpress tools and terminals/connectors together form a Crimp System where the crimp results are supervised to meet requirements of established standards like IEC60352-2, SEN 245010, DIN46249, BS4579:1 and other.

Many of the most common tools have symmetrical crimp die nests to enable crimps from both tool sides - a feature certainly appreciated by left-handed users.

All Miniforce type G- and D-tools are produced from high grade Swedish steel with black finish surface and comprehensive laser markings.



Certification of crimp tools

Quality assurance of our tools is made by certification, already in the manufacturing process, of the crimping tools, both hand tools type Gxx, i.e. the Miniforce tools, and type Dxx tools.



What is certified?

The certification of Elpress crimp tools comprises individual documentation from final assembly and inspection regarding:

- **handle pre-load**, which is the force needed to release the crimp completion ratchet
- **crimp die nest heights**, which means each of the greatest nest heights to be measured with completely closed dies.

Why certification?

The certificate that accompanies the tool has several functions:

- New crimp tools are often immediately introduced into a QA system. The tool status before use is then of course to

be the first log entry. Later periodic inspection recordings may then form base for detection of changes or wear and of possibly necessary corrective actions.

- The certificate shows that each individual tool meets the design specifications before supply.
- The certificate indicates the most important tool properties to be followed up.

Elpress service department offers continued follow up on the quality of the tools.



Elpress certificate.





Pre-insulated end terminals 0.14 - 50 mm² ET, standard colour

■ Data: Cu 99.95%, tin plated. CSA approved.

■ Insulation polypropylene, dimensions according to DIN 46228, colour code W.



	AWG	mm ²	Cat. no.	mm d	L ₁	L	s	Rec. tool	Pcs/pack
Grey	26	0,14	A0,14-6ET*	2,0	6	10,5	8	EEB0160	500
			A0,14-8ET*	2,0	8	12,5	10	EEB0160	500
Light Blue	24	0,25	A0,25-6ET*	2,0	6	10,5	8	EEB0160	100
			A0,25-8ET*	2,0	8	12,5	10	EEB0160	500
Green	24	0,34	A0,34-6ET*	2,0	6	10,5	8	EEB0160	100
			A0,34-8ET*	2,0	8	12,5	10	EEB0160	100
Orange	20	0,5	A0,5-6ET	2,5	6	11,5	8	EEB0160	100
			A0,5-8ET	2,5	8	13,5	10	EEB0160	100
			A0,5-10ET	2,5	10	15,5	12	EEB0160	100
Yellow	20	0,75	A0,75-6ET	2,8	6	12,0	8	EEB0160	100
			A0,75-8ET	2,8	8	14,0	10	EEB0160	100
			A0,75-10ET	2,8	10	16,0	12	EEB0160	100
			A0,75-12ET	2,8	12	18,0	14	EEB0160	100
Yellow	18	1	A1-6ET	3,0	6	12,5	8	EEB0160	100
			A1-8ET	3,0	8	14,5	10	EEB0160	100
			A1-10ET	3,0	10	16,5	12	EEB0160	100
			A1-12ET	3,0	12	18,5	14	EEB0160	100
Red	16	1,5	A1,5-6ET*	3,4	6	12,5	8	EEB0160	100
			A1,5-8ET	3,4	8	14,5	10	EEB0160	100
			A1,5-10ET	3,4	10	16,5	12	EEB0160	100
			A1,5-12ET	3,4	12	18,5	14	EEB0160	100
			A1,5-18ET	3,4	18	24,5	20	EEB0160	100
Yellow	14	2,08	A2,08-8ET*	3,6	8	14,5	10	EEB0160	100
Blue	14	2,5	A2,5-8ET	4,2	8	15,0	10	EEB0160	100
			A2,5-10ET	4,2	10	17,0	12	EEB0160	100
			A2,5-12ET	4,2	12	19,0	14	EEB0160	100
			A2,5-18ET	4,2	18	25,0	20	EEB0160	100
Grey	12	4	A4-10ET	4,8	10	18	12	EEB0160	100
			A4-12ET	4,8	12	20,0	14	EEB0160	100
			A4-18ET	4,8	18	26,0	20	EEB0160	100
Black	10	6	A6-12ET	6,2	12	20	14	EEB0160	100
			A6-18ET	6,2	18	26	20	EEB0160	100
Light Green	8	10	A10-12ET	7,5	12	21	14	GEB1025	100
			A10-18ET	7,5	18	27	20	GEB1025	100
Green	6	16	A16-12ET	8,8	12	23	14	GEB1025	100
			A16-18ET	8,8	18	29	20	GEB1025	100
Brown	4	25	A25-16ET	11,0	16	29	18	GEB1025	50
			A25-18ET	11,0	18	31,0	20	GEB1025	50
			A25-22ET	11,0	22	35	24	GEB1025	50
Yellow	2	35	A35-16ET	12,5	16	30	18	GEB3550	50
			A35-18ET	12,5	18	32,0	20	GEB3550	50
			A35-25ET	12,5	25	39	27	GEB3550	50
Light Green	1/0	50	A50-20ET	15,0	20	36,0	22	GEB3550	50
			A50-25ET	15,0	25	41,0	27	GEB3550	50

* does not conform to DIN 46228
s = strip length
For larger areas than 50 mm², contact Elpress.

For detailed information regarding recommended tool, see tool section at the end of this chapter.



Pre-insulated end terminals 0.14 - 50 mm² ETT, alternative colour

■ Data: Cu 99.95%, tin plated. CSA approved.

■ Insulation polypropylene, dimensions according to DIN 46228, colour code T.



	AWG	mm ²	Cat. no.	mm d	L ₁	L	s	Rec. tool	Pcs/pack
■	26	0,14	A0,14-6ETT*	2,0	6	10,5	8	EEB0160	500
			A0,14-8ETT*	2,0	8	12,5	10	EEB0160	500
■	24	0,25	A0,25-6ETT*	2,0	6	10,5	8	EEB0160	100
			A0,25-8ETT*	2,0	8	12,5	10	EEB0160	500
■	22	0,34	A0,34-6ETT*	2,0	6	10,5	8	EEB0160	100
			A0,34-8ETT*	2,0	8	12,5	10	EEB0160	100
■	20	0,5	A0,5-6ETT	2,5	6	11,5	8	EEB0160	100
			A0,5-8ETT	2,5	8	13,5	10	EEB0160	100
			A0,5-10ETT	2,5	10	15,5	12	EEB0160	100
■	20	0,75	A0,75-6ETT	2,8	6	12,0	8	EEB0160	100
			A0,75-8ETT	2,8	8	14,0	10	EEB0160	100
			A0,75-10ETT	2,8	10	16,0	12	EEB0160	100
			A0,75-12ETT	2,8	12	18,0	14	EEB0160	100
■	18	1	A1-6ETT	3,0	6	12,5	8	EEB0160	100
			A1-8ETT	3,0	8	14,5	10	EEB0160	100
			A1-10ETT	3,0	10	16,5	12	EEB0160	100
			A1-12ETT	3,0	12	18,5	14	EEB0160	100
■	16	1,5	A1,5-6ETT*	3,4	6	12,5	8	EEB0160	100
			A1,5-8ETT	3,4	8	14,5	10	EEB0160	100
			A1,5-10ETT	3,4	10	16,5	12	EEB0160	100
			A1,5-12ETT	3,4	12	18,5	14	EEB0160	100
			A1,5-18ETT	3,4	18	24,5	20	EEB0160	100
■	14	2,08	A2,08-8ETT*	3,6	8	14,5	10	EEB0160	100
■	14	2,5	A2,5-8ETT	4,2	8	15,0	10	EEB0160	100
			A2,5-10ETT	4,2	10	17,0	12	EEB0160	100
			A2,5-12ETT	4,2	12	19,0	14	EEB0160	100
			A2,5-18ETT	4,2	18	25,0	20	EEB0160	100
■	12	4	A4-10ETT	4,8	10	17,5	12	EEB0160	100
			A4-12ETT	4,8	12	20,0	14	EEB0160	100
			A4-18ETT	4,8	18	26,0	20	EEB0160	100
■	10	6	A6-12ETT	6,2	12	20	14	EEB0160	100
			A6-18ETT	6,2	18	26	20	EEB0160	100
■	8	10	A10-12ETT	7,5	12	21	14	GEB1025	100
			A10-18ETT	7,5	18	27	20	GEB1025	100
■	6	16	A16-12ETT	8,8	12	23	14	GEB1025	100
			A16-18ETT	8,8	18	29	20	GEB1025	100
■	4	25	A25-16ETT	11,0	16	29	18	GEB1025	50
			A25-18ETT	11,0	18	31,0	20	GEB1025	50
			A25-22ETT	11,0	22	35	24	GEB1025	50
■	2	35	A35-16ETT	12,5	16	30	18	GEB3550	50
			A35-18ETT	12,5	18	32,0	20	GEB3550	50
			A35-25ETT	12,5	25	39	27	GEB3550	50
■	1/0	50	A50-20ETT	15,0	20	36,0	27	GEB3550	50
			A50-25ETT	15,0	20	36,0	22	GEB3550	50

* Does not conform to DIN 46228
s = strip length
For larger areas than 50 mm², contact Elpress.

For detailed information regarding recommended tool, see tool section at the end of this chapter.



Pre-insulated end terminals 0.14 - 50 mm² ETD, alternative colour

■ Data: Cu 99.95%, tin plated. CSA approved.

■ Insulation polypropylene, colour code and dimensions according to DIN 46228.



	AWG	mm ²	Cat. no.	mm d	L ₁	L	s	Rec. tool	Pcs/ pack
Grey	26	0,14	A0,14-6ETD*	2,0	6	10,5	8	EEB0160	500
			A0,14-8ETD*	2,0	8	12,5	10	EEB0160	500
Yellow	24	0,25	A0,25-6ETD*	2,0	6	10,5	8	EEB0160	100
			A0,25-8ETD*	2,0	8	12,5	10	EEB0160	500
Green	22	0,34	A0,34-6ETD*	2,0	6	10,5	8	EEB0160	100
			A0,34-8ETD*	2,0	8	12,5	10	EEB0160	100
Grey	20	0,5	A0,5-6ETD	2,5	6	11,5	8	EEB0160	100
			A0,5-8ETD	2,5	8	13,5	10	EEB0160	100
			A0,5-10ETD	2,5	10	15,5	12	EEB0160	100
Grey	20	0,75	A0,75-6ETD	2,8	6	12,0	8	EEB0160	100
			A0,75-8ETD	2,8	8	14,0	10	EEB0160	100
			A0,75-10ETD	2,8	10	16,0	12	EEB0160	100
			A0,75-12ETD	2,8	12	18,0	14	EEB0160	100
Red	18	1	A1-6ETD	3,0	6	12,5	8	EEB0160	100
			A1-8ETD	3,0	8	14,5	10	EEB0160	100
			A1-10ETD	3,0	10	16,5	12	EEB0160	100
			A1-12ETD	3,0	12	18,5	14	EEB0160	100
Black	16	1,5	A1,5-6ETD*	3,4	6	12,5	8	EEB0160	100
			A1,5-8ETD	3,4	8	14,5	10	EEB0160	100
			A1,5-10ETD	3,4	10	16,5	12	EEB0160	100
			A1,5-12ETD	3,4	12	18,5	14	EEB0160	100
			A1,5-18ETD	3,4	18	24,5	20	EEB0160	100
Yellow	14	2,08	A2,08-8ETD*	3,6	8	14,5	10	EEB0160	100
Blue	14	2,5	A2,5-8ETD	4,2	8	15,0	10	EEB0160	100
			A2,5-10ETD	4,2	10	17,0	12	EEB0160	100
			A2,5-12ETD	4,2	12	19,0	14	EEB0160	100
			A2,5-18ETD	4,2	18	25,0	20	EEB0160	100
Grey	12	4	A4-10ETD	4,8	10	17,5	12	EEB0160	100
			A4-12ETD	4,8	12	20,0	14	EEB0160	100
			A4-18ETD	4,8	18	26,0	20	EEB0160	100
Yellow	10	6	A6-12ETD	6,2	12	20	14	EEB0160	100
Red	8	10	A6-18ETD	6,2	18	26	20	EEB0160	100
			A10-12ETD	7,5	12	21	14	GEB1025	100
Red	8	10	A10-18ETD	7,5	18	27	20	GEB1025	100
			A16-12ETD	8,8	12	23	14	GEB1025	100
Blue	6	16	A16-18ETD	8,8	18	29	20	GEB1025	100
			A25-16ETD	11,0	16	29	18	GEB1025	50
Yellow	4	25	A25-18ETD	11,0	18	31,0	20	GEB1025	50
			A25-22ETD	11,0	22	35	24	GEB1025	50
			A35-16ETD	12,5	16	30	18	GEB3550	50
Red	2	35	A35-18ETD	12,5	18	32,0	20	GEB3550	50
			A35-25ETD	12,5	25	39	27	GEB3550	50
Blue	1/0	50	A50-20ETD	15,0	20	36,0	22	GEB3550	50
			A50-25ETD	15,0	25	41,0	27	GEB3550	50

* Does not conform to DIN46228.

s = strip length

For larger areas than 50 mm², contact Elpress.

For detailed information regarding recommended tool, see tool section at the end of this chapter.



Pre-insulated end terminals for short-circuit proof cable-insulations 1.5 - 16 mm²

■ Data: Cu 99.95%, tin plated, polypropylene insulation, colour code DIN.

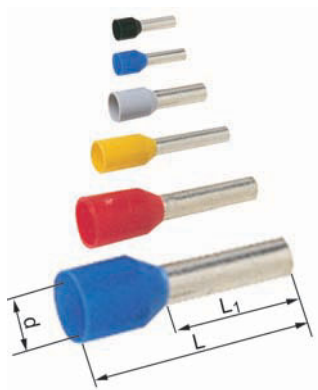

	mm ²	Cat. no.	mm d	L ₁	L	S	Rec. tool	Pcs/pack
■	1,5	A1,5-8ETDXL	6,9	8	17,5	11	EEB0160	100
		A1,5-10ETDXL	6,9	10	19,5	13	EEB0160	100
■	2,5	A2,5-8ETDXL	7,8	8	17,5	11	EEB0160	100
		A2,5-12ETDXL	7,8	12	21,5	15	EEB0160	100
■	4	A4-10ETDXL	7,8	10	19,5	13	EEB0160	100
■	6	A6-12ETDXL	8,3	12	23	15	EEB0160	100
■	10	A10-12ETDXL	9,8	12	24	15	GEB1025	100
■	16	A16-12ETDXL	12	12	25,5	15	GEB1025	100

s = stripping length

2

For detailed information regarding recommended tool, see tool section at the end of this chapter.



Un-insulated end terminals 0.25 - 240 mm²

■ Data: electrolytic copper, tin plated, dimensions according to DIN 46228.



AWG	mm ²	Cat. no.	mm d	L	s	Rec. tool	Pcs/pack	Note
24	0,25	B0,25-5ET	0,8	5	5	EEB0160	1000	1
		B0,25-7ET	0,8	7	7	EEB0160	1000	1
24	0,34	B0,34-5ET	0,9	5	5	EEB0160	1000	1
		B0,34-7ET	0,9	7	7	EEB0160	1000	1
20	0,5	B0,5-6ET	1	6	6	EEB0160	1000	1
		B0,5-8ET	1	8	8	EEB0160	1000	
		B0,5-10ET	1	10	10	EEB0160	1000	
20	0,75	B0,75-6ET	1,2	6	6	EEB0160	1000	1
		B0,75-8ET	1,2	8	8	EEB0160	1000	
		B0,75-10ET	1,2	10	10	EEB0160	1000	
		B0,75-12ET	1,2	12	12	EEB0160	1000	
18	1	B1-6ET	1,4	6	6	EEB0160	1000	1
		B1-8ET	1,4	8	8	EEB0160	1000	
		B1-10ET	1,4	10	10	EEB0160	1000	
		B1-12ET	1,4	12	12	EEB0160	1000	
16	1,5	B1,5-7ET	1,7	7	7	EEB0160	1000	1
		B1,5-8ET	1,7	8	8	EEB0160	1000	
		B1,5-10ET	1,7	10	10	EEB0160	1000	
		B1,5-12ET	1,7	12	12	EEB0160	1000	
		B1,5-15ET	1,7	15	15	EEB0160	1000	
		B1,5-18ET	1,7	18	18	EEB0160	1000	
		B1,5-20ET	1,7	10	10	EEB0160	1000	
14	2,5	B2,5-7ET	2,2	7	7	EEB0160	1000	1
		B2,5-8ET	2,2	8	8	EEB0160	1000	
		B2,5-10ET	2,2	10	10	EEB0160	1000	
		B2,5-12ET	2,2	12	12	EEB0160	1000	
		B2,5-15ET	2,2	15	15	EEB0160	1000	
		B2,5-18ET	2,2	18	18	EEB0160	1000	
		B2,5-20ET	2,2	20	20	EEB0160	1000	
12	4	B4-9ET	2,8	9	9	EEB0160	1000	1
		B4-10ET	2,8	10	10	EEB0160	1000	
		B4-12ET	2,8	12	12	EEB0160	1000	
		B4-15ET	2,8	15	15	EEB0160	1000	
		B4-18ET	2,8	18	18	EEB0160	1000	
		B4-20ET	2,8	20	20	EEB0160	1000	
10	6	B6-10ET	3,5	10	10	EEB0160	250	1
		B6-12ET	3,5	12	12	EEB0160	250	
		B6-15ET	3,5	15	15	EEB0160	250	
		B6-18ET	3,5	18	18	EEB0160	250	
		B6-20ET	3,5	20	20	EEB0160	250	
		B6-25ET	3,5	25	25	EEB0160	250	
8	10	B10-12ET	4,5	12	12	GEB1025	250	1
		B10-15ET	4,5	15	15	GEB1025	250	
		B10-18ET	4,5	18	18	GEB1025	250	
		B10-20ET	4,5	20	20	GEB1025	250	
		B10-25ET	4,5	25	25	GEB1025	250	
6	16	B16-12ET	5,8	12	12	GEB1025	250	1
		B16-15ET	5,8	15	15	GEB1025	250	
		B16-18ET	5,8	18	18	GEB1025	250	
		B16-20ET	5,8	18	18	GEB1025	250	
		B16-25ET	5,8	25	25	GEB1025	250	
		B16-32ET	5,8	32	32	GEB1025	250	

For detailed information regarding recommended tool, see tool section at the end of this chapter.

s = strip length
Note 1: Not according to DIN 46228.



AWG	mm ²	Cat. no.	mm d	L	s	Rec. tool	Pcs/pack	Note
4	25	B25-12ET	7,3	12	12	GEB1025	250	1
		B25-15ET	7,3	15	15	GEB1025	250	
		B25-18ET	7,3	18	18	GEB1025	250	
		B25-25ET	7,3	25	25	GEB1025	100	
		B25-32ET	7,3	25	25	GEB1025	100	
2	35	B35-18ET	8,3	18	18	GEB3550	100	1
		B35-20ET	8,3	20	20	GEB3550	100	
		B35-22ET	8,3	32	32	GEB3550	100	
		B35-25ET	8,3	25	25	GEB3550	100	
		B35-32ET	8,3	32	32	GEB3550	100	
1/0	50	B50-18ET	10,3	18	18	GEB3550	100	1
		B50-22ET	10,3	22	22	GEB3550	100	
		B50-25ET	10,3	25	25	GEB3550	100	
		B50-32ET	10,3	32	32	GEB3550	100	

s = strip length

Note 1: Not according to DIN 46228.

For larger areas than 50 mm², contact Elpress.

For detailed information regarding recommended tool, see tool section at the end of this chapter.



Pre-insulated TWIN end terminals 2x0.5 - 2x10 mm², ET2, standard colour

■ Data: electrolytic copper, tin plated, polypropylene insulation, colour code according to DIN 46228. Designed to connect two conductors in one terminal.



	AWG	mm ²	Cat. no.	mm d	H/D	L ₁	L	s	Pcs/pack	Rec. tool*
	2 x 20	2 x 0,5	A0,5-6ET2	1,5	2,3/4,5	6	11,5	8	100	EEB0160
			A0,5-8ET2	1,5	2,3/4,5	8	15,0	10	100	EEB0160
	2 x 20	2 x 0,75	A0,75-8ET2	1,8	2,6/5,1	8	15,0	10	100	EEB0160
			A0,75-10ET2	1,8	2,6/5,1	10	17,0	12	100	EEB0160
			A0,75-12ET2	1,8	2,6/5,1	12	18,0	14	100	EEB0160
■	2 x 18	2 x 1	A1-8ET2	2,0	3,0/5,1	8	15,0	10	100	EEB0160
			A1-10ET2	2,0	3,0/5,1	10	17,0	12	100	EEB0160
			A1-12ET2	2,0	3,0/5,1	12	18,5	14	100	EEB0160
■	2 x 16	2 x 1,5	A1,5-8ET2	2,3	3,5/6,4	8	16,0	10	100	EEB0160
			A1,5-12ET2	2,3	3,5/6,4	12	20	14	100	EEB0160
■	2 x 14	2 x 2,5	A2,5-10ET2	2,9	4,0/7,5	10	18,5	12	100	EEB0160
			A2,5-13ET2	2,9	4,0/7,5	13	21,5	15	100	EEB0160
■	2 x 12	2 x 4	A4-12ET2	3,8	4,9/8,6	12	23	14	100	GEB4010C-TWIN
			A4-18ET2	3,8	4,9/8,6	18	26,0	20	100	EEB0160
■	2 x 10	2 x 6	A6-14ET2	4,6	5,8/9,6	14	25	16	100	GEB4010C-TWIN
			A6-18ET2	4,6	5,8/9,6	18	26	20	100	GEB4010C-TWIN
■	2 x 8	2 x 10	A10-14ET2	6,5	7,0/12,6	14	26	16	100	GEB4010C-TWIN

s = strip length

* Use die nest marked closest to the total cross section area in the terminal

For detailed information regarding recommended tool, see tool section at the end of this chapter.



Pre-insulated TWIN end terminals 2x0.5 - 2x10 mm², ETT2, alternative colour

■ Data: electrolytic copper, tin plated, polypropylene insulation, colour code according to DIN 46228, type T. Designed to connect two conductors in one terminal.



	AWG	mm ²	Cat. no.	mm d	H/D	L ₁	L	s	Pcs/pack	Rec. tool*
	2 x 20	2 x 0,5	A0,5-6ETT2	1,5	2,3/4,5	6	13,0	8	100	EEB0160
			A0,5-8ETT2	1,5	2,3/4,5	8	15,0	10	100	EEB0160
■	2 x 20	2 x 0,75	A0,75-8ETT2	1,8	2,6/5,1	8	15,0	10	100	EEB0160
			A0,75-10ETT2	1,8	2,6/5,1	10	17,0	12	100	EEB0160
			A0,75-12ETT2	1,8	2,6/5,1	12	18,0	14	100	EEB0160
■	2 x 18	2 x 1	A1-8ETT2	2,0	3,0/5,1	8	15,0	10	100	EEB0160
			A1-10ETT2	2,0	3,0/5,1	10	17,0	12	100	EEB0160
			A1-12ETT2	2,0	3,0/5,1	12	18,5	14	100	EEB0160
■	2 x 16	2 x 1,5	A1,5-8ETT2	2,3	3,5/6,4	8	16,0	10	100	EEB0160
			A1,5-12ETT2	2,3	3,5/6,4	12	20	14	100	EEB0160
■	2 x 14	2 x 2,5	A2,5-10ETT2	2,9	4,0/7,5	10	18,5	12	100	EEB0160
			A2,5-13ETT2	2,9	4,0/7,5	13	21,5	15	100	EEB0160
■	2 x 12	2 x 4	A4-12ETT2	3,8	4,9/8,6	12	23	14	100	GEB4010C-TWIN
			A4-18ETT2	3,8	4,9/8,6	18	26,0	20	100	EEB0160
■	2 x 10	2 x 6	A6-14ETT2	4,6	5,8/9,6	14	25	16	100	GEB4010C-TWIN
			A6-18ETT2	4,6	5,8/9,6	18	26	20	100	GEB4010C-TWIN
■	2x8	2 x 10	A10-14ETT2	6,5	7,0/12,6	14	26	16	100	GEB4010C-TWIN

s = strip length

* Use die nest marked closest to the total cross section area in the terminal

Pre-insulated TWIN end terminals 2x0.5 - 2x10 mm², ETW2, alternative colour

■ Data: electrolytic copper, tin plated, polypropylene insulation, colour code according to DIN 46228, type W. Designed to connect two conductors in one terminal.

	AWG	mm ²	Cat. no.	mm d	H/D	L ₁	L	s	Pcs/pack	Rec. tool*
■	2 x 20	2 x 0,5	A0,5-6ETW2	1,5	2,3/4,5	6	13,0	8	100	EEB0160
			A0,5-8ETW2	1,5	2,3/4,5	8	15,0	10	100	EEB0160
	2 x 20	2 x 0,75	A0,75-8ETW2	1,8	2,6/5,1	8	15,0	10	100	EEB0160
			A0,75-10ETW2	1,8	2,6/5,1	10	17,0	12	100	EEB0160
			A0,75-12ETW2	1,8	2,6/5,1	12	18,0	14	100	EEB0160
■	2 x 18	2 x 1	A1-8ETW2	2,0	3,0/5,1	8	15,0	10	100	EEB0160
			A1-10ETW2	2,0	3,0/5,1	10	17,0	12	100	EEB0160
			A1-12ETW2	2,0	3,0/5,1	12	18,5	14	100	EEB0160
■	2 x 16	2 x 1,5	A1,5-8ETW2	2,3	3,5/6,4	8	16,0	10	100	EEB0160
			A1,5-12ETW2	2,3	3,5/6,4	12	20	14	100	EEB0160
■	2 x 14	2 x 2,5	A2,5-10ETW2	2,9	4,0/7,5	10	18,5	12	100	EEB0160
			A2,5-13ETW2	2,9	4,0/7,5	13	21,5	15	100	EEB0160
■	2 x 12	2 x 4	A4-12ETW2	3,8	4,9/8,6	12	23	14	100	GEB4010C-TWIN
			A4-18ETW2	3,8	4,9/8,6	18	26,0	20	100	EEB0160
■	2 x 10	2 x 6	A6-14ETW2	4,6	5,8/9,6	14	25	16	100	GEB4010C-TWIN
			A6-18ETW2	4,6	5,8/9,6	18	26	20	100	GEB4010C-TWIN
■	2 x 8	2 x 10	A10-14ETW2	6,5	7,0/12,6	14	26	16	100	GEB4010C-TWIN

s = strip length

* Use die nest marked closest to the total cross section area in the terminal

For detailed information regarding recommended tool, see tool section at the end of this chapter.



Assortment boxes

PL800ET



Elpress assortment box designed for professional use.

- manufactured from polypropylene, insert from polystyrene
- 11 partitions
- 800 pre-insulated terminals type ET, colour code W, 0.5 - 16 mm²
- crimping tool TEB0516, stripping and cutting tool SCT001
- weight 0.90 kg, length 246 mm, width 171 mm, height 57 mm

PL900ET



Elpress assortment box designed for various professional use.

- manufactured from polypropylene, insert from polystyrene
- 11 partitions
- 900 pre-insulated end terminals type ET, colour code W, 0.5 - 6 mm²
- crimping tool EEB0160, stripping and cutting tool SCT001
- weight 1.0 kg, length 246 mm, width 171 mm, height 57 mm

SD4016



Elpress mini assortment box.

- 4 partitions
- 150 pre-insulated end terminals type ET, colour code W, 4 - 16 mm²
- weight 90 g
- Ø 90 mm, height 40 mm

SD0525



Elpress mini assortment box.

- 5 partitions
- 400 pre-insulated end terminals type ET, colour code W, 0.5 - 2.5 mm²
- weight 90 g
- Ø 90 mm, height 40 mm



Certified Miniforce tools for end terminals 0.25 - 4 mm²



Technical data:

- unique mechanism that reduces maximum handle force with 30% compared to the earlier Exx version
- ratchet system to guarantee a fully closed crimp
- release mechanism if the crimping sequence must be interrupted
- symmetrical and distinctly laser marked die nests
- adjustable if changes occur, ie after many crimps
- tested with Elpress terminals
- ergonomically designed handles to fit all users
- optimises the quality of the crimp result
- reduces the risk for repetitive strain injuries (RSI)
- light and handy design without reduction in durability
- type C has extra long handles for two hand grip
- at least 80 000 crimps
- delivered with certificate for quality assurance

2

Crimp range 0.25 - 4 mm²

GSEA0340C

Miniforce combination crimp tool for crimping of both;

- pre-insulated terminals 0.5 - 2.5 mm² and
- pre-insulated and un-insulated end terminals 0.25 - 4 mm²

GSEA0340C



Crimp types



Area	Cat. no.	Crimp types	Weight	Length x Width
0.25-4 mm ²	GSEA0340C	oval, symmetrical, trapezoid	0.682 kg	255 x 72 mm



Certified crimp tools for end terminals (ferrules) 0.25 - 16 mm²



Technical data (type DEB):

- distinctly marked die nests
- ratchet system to guarantee a fully closed crimp
- emergency release if the crimping sequence must be interrupted
- adjustable if changes occur, ie after many crimps
- tested according to DIN requirements
- unique design makes the tools compact and handy
- requires a minimum of muscle force for a perfect crimp
- fits all users
- at least 50.000 crimps
- delivered with certificate for quality assurance (DEB-type)

Crimp range 0.25 - 2.5 mm²

DEB0325

Crimp tool for crimping of pre-insulated and un-insulated end terminals, front feed.

DEB0325



Crimp type



Area	Cat. no.	Crimp type	Weight	Length x Width
0.25-2.5 mm ²	DEB0325	trapezoid	0.453 kg	192 x 66 mm

Crimp range 0.5 - 6 mm²

DEB0560

Crimp tool for crimping of pre-insulated and un-insulated end terminals.

DEB0560



Crimp type



Area	Cat. no.	Crimp type	Weight	Length x Width
0.5-6 mm ²	DEB0560	trapezoid	0.452 kg	192 x 66 mm

**Crimp range 0.25 - 2,5 mm²**

T2104

T2104



Crimp type



Crimp tool for pre-insulated and un-insulated end terminals 0.25 - 2.5 mm². This crimp tool does not have a full closure ratchet mechanism. Certificate is not included.

Area	Cat. no.	Crimp type	Weight	Length
0.25-2.5 mm ²	T2104	trapezoid	0.160 kg	150 mm

2

Crimp range 0.25 - 16 mm²

TEB0516

TEB0516



Crimp type



Crimp tool for crimping of pre-insulated and un-insulated end terminals 0.5 - 16 mm².

This crimp tool does not have a full closure ratchet mechanism. Certificate is not included.

Area	Cat. no.	Crimp type	Weight	Length
0.25-16 mm ²	TEB0516	indent	0.320 kg	185 mm



Certified Miniforce tools for end terminals (ferrules) 0.1 - 6 mm² and TWIN end terminals 2x0.5 - 2x10 mm²



Technical data:

- ratchet system to guarantee a fully closed crimp
- release mechanism if the crimping sequence must be interrupted
- distinctly marked die nests
- adjustable if changes occur, ie after many crimps
- tested with Elpress terminals according to DIN requirements
- ergonomically designed handles to fit all users
- optimises the crimp quality
- reduces the risk for repetitive strain injuries (RSI)
- light and handy design without reduction in durability
- type C has extra long handles for comfortable two-hand grip
- at least 80.000 crimps
- delivered with certificate for quality assurance

Self setting crimp range 0.1 - 6 mm²

EEB0160

Miniforce **self-setting** tool for crimping pre-insulated and un-insulated end terminals 0.1 - 6 mm² and pre-insulated TWIN end terminals 2x0.5 - 2x4 mm².

Particulars:

- only one crimp nest, which automatically sets to the appropriate size for the end terminal crimped
- front feed
- accepts crimp lengths up to 20 mm

EEB0160



Crimp type



Area	Cat. no.	Crimp type	Weight	Length x Width
0.1-6 mm ²	EEB0160	trapezoid	0.551 kg	220 x 72 mm

Self setting crimp range 0.5 - 6 mm²

PZD3

Self-setting tool for crimping pre-insulated and un-insulated end terminals 0.5 - 6 mm² and pre-insulated TWIN end terminals 2x0.5 - 2x4 mm².

Particulars:

- only one crimp nest which automatically sets to the appropriate size for the end terminal crimped; leaves a crimp surface with shallow transversal grooves
- front feed
- crimp lengths up to 17 mm

PZD3



Crimp type



Area	Cat. no.	Crimp type	Weight	Length x Width
0.5-6 mm ²	PZD3	square	0.472 kg	192 x 66 mm



Crimp range 4 - 10 mm²

GEB4010C-TWIN

Miniforce tool for crimping of pre-insulated TWIN end terminals.

GEB4010C-TWIN



Crimp type



Particulars:

- unique mechanism that reduces maximum handle force with 30% compared to the earlier Exx version

Area	Cat. no.	Crimp type	Weight	Length x Width
4-10 mm ²	GEB4010C-TWIN	trapezoid	0.689 kg	255 x 72 mm

2



Certified Miniforce tools for end terminals 4 - 50 mm²



Technical data:

- unique mechanism that reduces maximum handle force with 30% compared to the earlier Exx version
- ratchet system to guarantee a fully closed crimp
- release mechanism if the crimping sequence must be interrupted
- distinctly marked die nests
- adjustable if changes occur, ie after many crimps
- tested with Elpress terminals according to DIN requirements
- ergonomically designed handles to fit all users
- optimises the crimp quality
- reduces the risk for repetitive strain injuries (RSI)
- light and handy design without reduction in durability
- type C has extra long handles for comfortable two-hand grip
- at least 80.000 crimps
- delivered with certificate for quality assurance

Crimp range 4 - 10 mm²

GEB4010 and GEB4010C

Miniforce crimp tool for crimping pre-insulated and un-insulated end terminals.

GEB4010



GEB4010C



Crimp type



Area	Cat. no.	Crimp type	Weight	Length x Width
4-10 mm ²	GEB4010	trapeziod	0.653 kg	220 x 72 mm
4-10 mm ²	GEB4010C	trapeziod	0.692 kg	255 x 72 mm

Crimp range 6 - 16 mm²

GEB0616C

Miniforce crimp tool for crimping pre-insulated and un-insulated end terminals.

GEB0616C



Crimp type



Area	Cat. no.	Crimp type	Weight	Length x Width
6-16 mm ²	GEB0616C	trapezoid	0.689 kg	255 x 72 mm



Crimp range 10 - 25 mm²

GEB1025 and GEB1025C

Miniforce crimp tool for crimping pre-insulated and un-insulated end terminals.

GEB1025



GEB1025C



Crimp type



Area	Cat. no.	Crimp type	Weight	Length x Width
10-25 mm ²	GEB1025	trapezoid	0.657 kg	220 x 72 mm
10-25 mm ²	GEB1025C	trapezoid	0.691 kg	255 x 72 mm



Crimp range 35 - 50 mm²

GEB3550 and GEB3550C

Miniforce crimp tool for crimping pre-insulated and un-insulated end terminals.

GEB3550



GEB3550C



Crimp geometry



Area	Cat. no.	Crimp type	Weight	Length x Width
35-50 mm ²	GEB3550	trapezoid	0.654 kg	220 x 72 mm
35-50 mm ²	GEB3550C	trapezoid	0.691 kg	255 x 72 mm



Elpress Mobile - a tool with interchangeable dies



Professional crimp tool with interchangeable dies for electrical installation and data-com.

Technical data:

- a reliable, safe, economical and comfortable tool
- parallel-action stroke with a maximum force of 10 000 N, tested for 20000 crimps
- easily interchangeable crimp dies with one handgrip
- the dies are kept together as pairs with a special rod to simplify handling
- a wide range of crimping dies enables the user to cover 20-30 applications in just one tool frame

You purchase Elpress Mobile in four basic versions:

Elpress Mobile

Mobile handtool (only the frame). Dies supplemented.

Cat. no.	Weight	Length x Width
Elpress Mobile	0.554 kg	234 x 64 mm



Mobile, only the frame.

Mobile Installation

Mobile hand tool and two interchangeable dies:

- die OAA0525 for crimping of insulated terminals 0.5 - 2.5 mm²
- die OEB0210 for crimping of end sleeves 0.25 - 10 mm²
- the tool is delivered with dies in a plastic packaging

Cat. no.	Weight	Length x Width
Mobile Installation	0.694 kg	234 x 64 mm



Mobile + dies OAA0525 and OEB0210.



Mobile DataCom

Mobile hand tool and two interchangeable dies:

- die OMP45 for crimping of modular plug, RJ45 contacts
- die OCC1113 for crimping of coaxial contacts RG58, 59, 62, 71
- the tool is delivered with dies in a plastic packaging



Mobile + dies OMP45 and OCC1113.

Cat. no.	Weight	Length x Width
Mobile DataCom	0.659 kg	234 x 64 mm

2

Mobile Solar Kit

Mobile hand tool for Solar panel installations including tool, three interchangeable dies and cable stripper LOKE for solar panel cable with extra thick insulation.

- OMS4, for crimping of Solar type connectors \varnothing 4 mm, with open barrel conductor crimp 2.5-6.0 mm²
- OMS3, for crimping of Solar connectors \varnothing 3 mm, turned pin type 2.5 - 6.0 mm²
- OMSL, for crimping of Solar connectors, turned pin type, Solar Lock 2.5 - 6.0 mm²



Mobile + dies OMS4, OMS3 and OMSL

Cat. no.	Weight	Length x Width
Mobile Solar Kit	0.722 kg	234 x 64 mm



Cable stripper LOKE.

Mobile Box

Box for the Mobile tool which has place for the tool and 5-6 dies. The Mobile tool and dies are ordered separately.

Cat. no.	Weight	Length x Width	Height
Mobile Box	0.320 kg	246 x 218 mm	56.5 mm



Additional dies to Elpress Mobile are presented in the table on the following page.



You complete your kit with these dies

Additional dies to Elpress Mobile. All dies have the same easy and fast fastening in the frame. The dies are kept together as pairs and delivered in a plastic cassette which can be put together with other cassettes.



OAA0160
For crimping of pre-insulated terminals 0.1 - 0.5 & 4 - 6 mm².



OAA0525
For crimping of pre-insulated terminals 0.5 - 2.5mm².



OSW0360
For crimping of through connectors with heat shrink insulation 0.3-0.75 and 4-6 mm²



OSW0525
For crimping of through connectors with heat shrink insulation 0.5-1.5 and 1.5-2.5 mm²



OPB0140
For crimping of global power connectors, GPC.



OPB6099
For crimping of global power connectors, GPC.



OWB4099
For W-crimping of un-insulated terminals 4 - 10 mm².



OKB0725
For indent crimping of un-insulated terminals 0.75 - 2.5 mm².



OKB0560
For indent crimping of un-insulated terminals 0.5 - 6 mm².



OEB0210
For crimping of end terminals 0.25 - 10 mm².



OEB1625
For crimping of end terminals 16 - 25 mm².



OEB3550
For crimping of end terminals 35 - 50 mm².



ORB0110
For roll crimping of terminals 0.1 - 1.0 mm².



ORB0560
For roll crimping of terminals 0.5 - 6 mm².



OMP45
For crimping of modular-plug RJ45.



OMP11
For crimping of modular-plug RJ11.



OFO5432
For crimping of fiber optics connections type ST, SC, SMA, SMB, SFR.



OCC0908
For crimping of coaxial contacts type BNC, TNC, RG174, RG179.



OCC1113
For crimping of coaxial contacts type BNC, TNC, RG58, RG59, RG62, RG71.



OCC4755
For crimping of coaxial contacts type CATV, RG6, RG59.



OMS4
For crimping of solar connectors Ø 4 mm, with open barrel conductor crimp 2.5 - 6.0 mm².



OMS3
For crimping of solar connectors Ø 3 mm, turned pin type 2.5- 6.0 mm².



OMSL
For crimping of solar connectors turned pin type Solar Lock 2.5- 6.0 mm².





Battery powered crimp tool



PV130P, PV130S - Elpress Mini.

Technical data:

- NiMh battery power (9.6 V and 1.3 Ah), recharge time approx. 40 minutes
- advanced ergonomoy for excellent access in confined areas
- tool for service and installation work
- fast crimping 2-4 seconds
- approx. 150 crimps per charge
- crimp ranges see table below
- supplied in a plastic case with battery charger and one battery

Crimp range 0.5-6, 0.25-10, 0.5-50 mm²

PV130P - Elpress Mini

Battery powered tool for parallel action crimping of pre-insulated terminals up to 6 mm², un-insulated terminals up to 10 mm² and end terminals up to 50 mm².

Included:

- Battery: PVBP1-MH
- Charger: PVBC2

Area	Cat. no.	Weight	Length
0.5-6/0.25-10/0.5-50 mm ²	PV130P - Elpress Mini	1.3 kg	360 mm



PV130P, box and charger.

PV130S - Elpress Mini

Battery powered tool for scissor crimping movement of pre-insulated terminals up to 6 mm², un-insulated terminals up to 10 mm² and end terminals up to 50 mm².

Included:

- Battery: PVBP1-MH
- Charger: PVBC2

Area	Cat. no.	Weight	Length
0.5-6/0.25-10/0.5-50 mm ²	PV130S - Elpress Mini	1.5 kg	360 mm



EB0560

WB4099

KB0325



EB3550

EB1025

EB4010



RB0560

Die table

	PV130P	PV130S
Application	Die	Die
Pre-insulated 0.5-6 mm ²	SA0760	SA0760
Un-insulated, indent crimp 0.25-2,5 mm ²	KB0325	KB0325
Un-insulated, W crimp 4-10 mm ²	WB4099	WB4099
Un-insulated, roll-crimp 0.5-6 mm ²	RB0560	RB0560
End terminals (ferrules)		
0.5-6 mm ²	EB0560	EB0560
4-10 mm ²	EB4010	EB4010
10-25 mm ²	EB1025	EB1025
35-50 mm ²	EB3550	EB3550

Remember to specify dies when you order a tool.



Un-insulated terminals and tools

General information about un-insulated terminals	2
Handtools for un-insulated terminals	3
Ring terminals 0.25 - 6 mm ²	4
Tube terminals 0.75 - 10 mm ²	5
Fork terminals 0.25 - 10 mm ²	5
Pin terminals 0.25 - 6 mm ²	6
Through connectors 0.75 - 10 mm ²	6
Receptacles 0.5 - 6 mm ²	6
Receptacles with locking lip 0.5 - 6 mm ²	7
Multiple tabs 0.5 - 2.5 mm ²	7
Receptacle, 90°, 0.5 - 1.5 mm ²	7
Receptacle 90°, 0.5 - 1 mm ²	7
Tabs 0.5 - 2.5 mm ²	8
Tabs with locking lip 0.5 - 6 mm ²	8
Bullets 0.2 - 1.5 mm ²	8
Sockets 0.2 - 1.5 mm ²	8
Tabs	9
Tabs for soldering	10
Insulation boots	11
Connector blocks	12
Assortment box	13
Hobby tools for crimping terminals 0.5 - 6 mm ²	14
Certified tools for un-insulated terminals 0.15 - 6 mm ²	15
Certified Miniforce tools for un-insulated terminals 0.5 - 10 mm ²	16
Elpress Mobile - a tool with interchangeable dies	18
Battery powered crimp tool	21
Tool for Cu terminals 4 - 16 mm ²	22



General information about un-insulated terminals

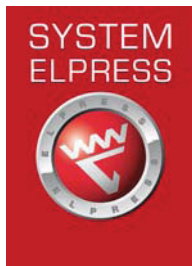

System Elpress

System Elpress consists of connectors and tools tested together for optimum connection result. The System concept makes you as a customer able to feel secure when using our system and to be sure a safe connection is made when Elpress products are used correctly.

Un-insulated terminals

Elpress un-insulated ring, tube terminals, forks, pins and connectors are produced from high grade 99.95% copper. The receptacles, tabs, bullets and sockets are produced from brass. All types are electrolytically tin plated for good corrosion protection.

Rings, forks and pins have brazed necks to allow crimping in all radial directions.

Markings

Elpress un-insulated terminals are, when possible, marked with logotype, max. cross section area and possible screw size to facilitate identification, inspection and crimp system work.

Example of product designation

Cat. no. B1532R (G, HO, FLS etc.)

B = un-insulated

15 = conductor cross section area (1,5 mm²)

32 = Characteristic dimension (Hole Ø 3,2 mm)

G = fork terminal

GS= fork terminal

H = tab

HN = tab

HA = bullet

HO = socket

R = ring terminal

SR = pin

FLS = receptacle, rolled type

FLSB = receptacle 90° rolled type

FLSH = multiple tabs

FLSN = receptacle with locking lip

FLSV = receptacle angled rolled type



Crimped samples of Elpress un-insulated terminals.



UL approved terminals

UL is an American standard which is also internationally accepted. Elpress standard Cu terminals of types KR/KS, KRF/KSF, KRT/KST are UL approved according to no. E205350. Cu terminals of types KR/KS, KRF/KSF are for stranded and flexible copper wires, classes 2 and 5 according to IEC 60228, and have a working area of 1-500 mm².

Screws and washers

The following apply to bright galvanized nuts and screws in strength class 8.8 used for connecting terminals to Cu and Al bus bars:

- Always use a torque wrench to ensure that they are tightened to the right torque. Ensure it is regularly calibrated in accordance with the supplier's instructions.
- Use the recommended torque in accordance with the screw manufacturer's instructions.
- Always use a hard flat washer to reduce friction between the installation surface and hole edge pressure, min hardness HB200.
- A spring washer in accordance with DIN 6796 may be used together with a flat washer to further increase strength in advanced applications.
- Assemble as shown in image.

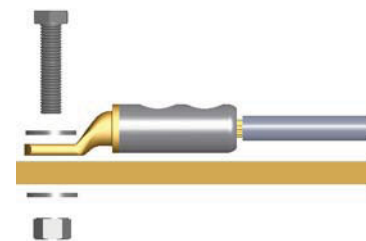

Screw	Tightening torque (Nm)
M5	5
M6	9
M8	21
M10	41
M12	70
M14	110
M16	170
M20	340



Hand tools for un-insulated terminals

Mechanical hand tools

High quality, crimp performance and ergonomics are prime considerations of Elpress when developing mechanical crimp tools. Except for the hobby tools, all Elpress crimp tools have a full closure, ratchet mechanism to ensure correct crimps at all instances - a prerequisite for professional and quality assured work.



Elpress Mobile, a professional crimp tool with interchangeable dies.

Miniforce tool

With the unique Miniforce range of crimp tools, a new level of performance was established when speaking of ergonomic adaption to the user and of low handle forces needed. A reduction of required force up to 45% is reached as a result of advanced ergonomic studies where minimised risk for work discomfort or even injuries was the main objective.



Miniforce type C has extra long handles for an easy two-hand grip which in most

cases represents a simple and natural way of lowering work loads.

Elpress tools and terminals/connectors together form a Crimp System where the crimp results are supervised to meet requirements of established standards like IEC60352-2, SEN 245010, DIN46249, BS4579:1 and other.

Many of the most common tools have symmetrical crimp die nests to enable crimps from both tool sides - a feature certainly appreciated by left-handed users.

All Miniforce type G- and D-tools are produced from high grade Swedish steel with black finish surface and comprehensive laser markings.



Certification of crimp tools

Quality assurance of our tools is made by certification, already in the manufacturing process, of the crimping tools, both hand tools type Gxx, i.e. the Miniforce tools, and type Dxx tools.



What is certified?

The certification of Elpress crimp tools comprises individual documentation from final assembly and inspection regarding:

- **handle pre-load**, which is the force needed to release the crimp completion ratchet
- **crimp die nest heights**, which means each of the greatest nest heights to be measured with completely closed dies.

Why certification?

The certificate that accompanies the tool has several functions:

- New crimp tools are often immediately introduced into a QA system. The tool status before use is then of course to

be the first log entry. Later periodic inspection recordings may then form base for detection of changes or wear and of possibly necessary corrective actions.

- The certificate shows that each individual tool meets the design specifications before supply.
- The certificate indicates the most important tool properties to be followed up.

Elpress service department offers continued follow up on the quality of the tools.

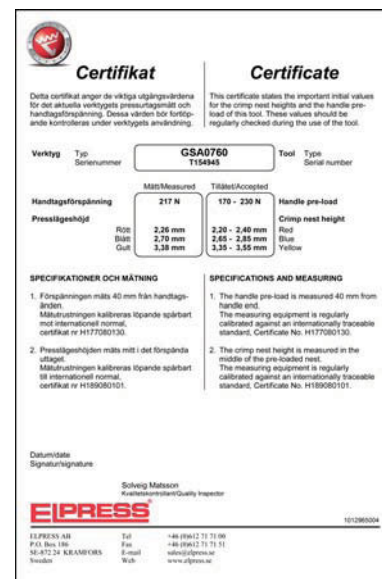

Elpress certificate.





Ring terminals 0.25 - 6 mm²

■ Data: Cu 99.95%, tin plated, brazed necks.



mm ²	Cat. no.	Screw	mm W	d	t	L	s	Pcs/ pack	Rec. tool
0,25-0,75	B0832R	M3	5,5	1,3	0,5	13,0	7	100	DKB0325
	B0843R	M4	7,5	1,3	0,5	16,2	7	100	DKB0325
	B0853R	M5	9,0	1,3	0,5	17,0	7	100	DKB0325
0,75-1,5	B1532R	M3	5,5	1,8	0,7	13,0	7	100	DKB0325, DKB0760
	B1543R	M4	7,5	1,8	0,7	16,2	7	100	DKB0325, DKB0760
	B1553R	M5	9,0	1,8	0,7	17,0	7	100	DKB0325, DKB0760
	B1565R	M6	11,0	1,8	0,7	20	7	100	DKB0325, DKB0760
	B1585R	M8	14,0	1,8	0,7	23	7	100	DKB0325, DKB0760
	B1510R	M10	17,0	1,8	0,75	26	7	100	DKB0325, DKB0760
1,5-2,5	B2532R	M3	6,0	2,3	0,8	15,0	8	100	DKB0325, DKB0760
	B2537R	M3,5	6,2	2,3	0,8	16,2	8	100	DKB0325, DKB0760
	B2543R	M4	7,5	2,3	0,8	16,2	8	100	DKB0325, DKB0760
	B2553R	M5	9,0	2,3	0,8	17,0	8	100	DKB0325, DKB0760
	B2565R	M6	11,0	2,3	0,8	20	8	100	DKB0325, DKB0760
	B2585R	M8	14,0	2,3	0,8	23	8	100	DKB0325, DKB0760
	B2510R	M10	17,0	2,3	0,75	26	8	100	DKB0325, DKB0760
4-6	B4643R	M4	7,8	3,4	1,0	17,9	9	100	DKB0760
	B4653R	M5	9,0	3,4	1,0	18,0	9	100	DKB0760
	B4665R	M6	11,0	3,4	1,0	20	9	100	DKB0760
	B4685R	M8	14,0	3,4	1,0	23	9	100	DKB0760
	B4610R	M10	17,0	3,4	1,0	27	9	100	DKB0760
	B4613R	M13	18,0	3,7	1,0	30	9	100	DKB0760

t = palm thickness s = strip length

For detailed information regarding recommended tool, see tool section at the end of this chapter.



Tube terminals 0.75 - 10 mm²

■ Data: Cu 99.95%, tin plated

■ Cable inspection hole, for flexible (class5) and stranded (class 2) Cu conductors.

■ UL-approved (1-10 mm²).

Marking example KR: 10 10 10 = mm² 10 = palm hole for M10



AWG	mm ²	Cat. no.	Screw	mm W	d	t	L	s	Pcs/pack	Rec. tool
(22)-18	0,75	KR0,75-3*	M3	6,0	1,3	0,8	16,0	7	100	DKB0325, DKB0760
(22)-18		KR0,75-4*	M4	6,0	1,3	0,8	17,0	7	100	DKB0325, DKB0760
(18)-16	1,5	KR1,5-3*	M3	6,5	1,8	1,0	16,0	7	100	DKB0325, DKB0760
(18)-16		KR1,5-4*	M4	6,5	1,8	1,0	17,0	7	100	DKB0325, DKB0760
(18)-16		KR1,5-5*	M5	7,5	1,8	0,8	18,0	7	100	DKB0325, DKB0760
(16)-14	2,5	KR2,5-3*	M3	7,5	2,3	1,3	17,0	8	100	DKB0325, DKB0760
(16)-14		KR2,5-4*	M4	7,5	2,3	1,3	18,0	8	100	DKB0325, DKB0760
(16)-14		KR2,5-5*	M5	8,5	2,3	1,2	19,0	8	100	DKB0325, DKB0760
(16)-14		KR2,5-6*	M6	8,5	2,3	1,1	19,0	8	100	DKB0325, DKB0760
12	4	KR4-4	M4	8,5	3,0	1,5	21	9	100	GWB4099, ES2258
12		KR4-5	M5	9,0	3,0	1,5	22	9	100	GWB4099, ES2258
12		KR4-6	M6	10,0	3,0	1,4	23	9	100	GWB4099, ES2258
10	6	KR6-4	M4	9,5	4,0	1,7	22	9	100	GWB4099, ES2258
10		KR6-5	M5	9,5	4,0	1,7	22	9	100	GWB4099, ES2258
10		KR6-6	M6	10,0	4,0	1,6	23	9	100	GWB4099, ES2258
10		KR6-8	M8	13,0	4,0	1,2	30	9	100	GWB4099, ES2258
8	10	KR10-5	M5	11,5	5,0	3,0	29	11	100	GWB4099, ES2258
8		KR10-6	M6	11,5	5,0	3,0	29	11	100	GWB4099, ES2258
8		KR10-8	M8	13,5	5,0	2,2	33	11	100	GWB4099, ES2258
8		KR10-10	M10	16,0	5,0	2,0	34	11	100	GWB4099, ES2258
8		KR10-12	M12	19,0	5,0	1,7	41	11	100	GWB4099, ES2258

t = palm thickness s = strip length
* without inspection hole

Fork terminals 0.25 - 10 mm²

■ Data: Cu 99.95%, tin plated, brazed necks.

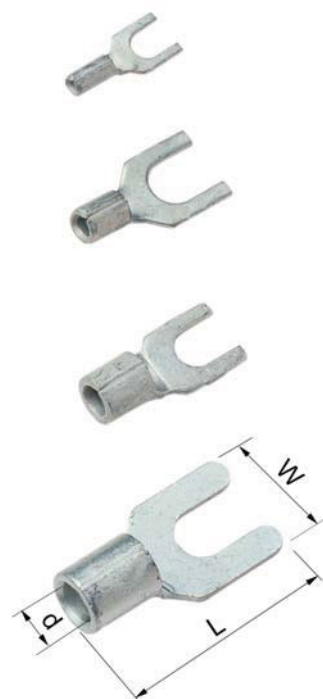

mm ²	Cat. no.	Screw	mm W	d	t	L	s	Pcs/pack	Rec. tool
0,25-0,75	B0832G	M3	5,5	1,3	0,5	13,0	7	100	DKB0325
	B0843G	M4	7,5	1,3	0,5	16,2	7	100	DKB0325
0,75-1,5	B1532G	M3	5,5	1,8	0,7	13,0	7	100	DKB0325, DKB0760
	B1537GS	M3,5	5,5	1,8	0,7	16,2	7	100	DKB0325, DKB0760
	B1543G	M4	7,0	1,8	0,7	16,2	7	100	DKB0325, DKB0760
	B1553G	M5	9,0	1,8	0,7	17,0	7	100	DKB0325, DKB0760
1,5-2,5	B2532G	M3	5,5	2,3	0,8	13,0	8	100	DKB0325, DKB0760
	B2543G	M4	7,0	2,3	0,8	16,2	8	100	DKB0325, DKB0760
	B2553G	M5	9,0	2,3	0,8	17,0	8	100	DKB0325, DKB0760
4-6	B4643G	M4	7,8	3,4	1,0	18,0	9	100	DKB0760, GWB4099
	B4653G	M5	9,0	3,4	1,0	18,0	9	100	DKB0760, GWB4099
10	B9953G	M5	12,0	4,6	1,2	24	11	100	GWB4099
	B9965G	M6	11,0	4,6	1,1	23	8	100	GWB4099

t = palm thickness s = strip length

For detailed information regarding recommended tool, see tool section at the end of this chapter.



Pin terminals 0.25 - 6 mm²

■ Data: Cu 99.95%, tin plated, brazed necks.

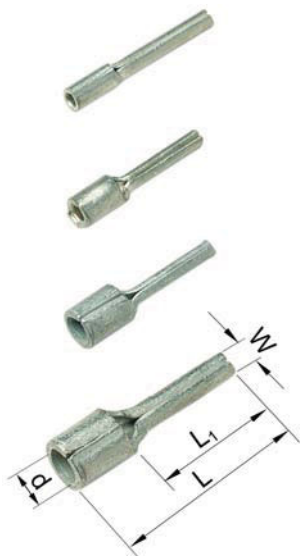

mm ²	Cat. no.	mm W	d	L ₁	L	s	Pcs/ pack	Rec. tool
0,25-0,75	B0819SR	1,8	1,3	12,0	17,0	7	100	DKB0325
0,75-1,5	B1519SR	1,9	1,8	12,0	17,0	7	100	DKB0325, DKB0760
1,5-2,5	B2519SR	1,9	2,3	12,0	17,0	8	100	DKB0325, DKB0760
4-6	B4630SR	2,8	3,4	14,0	20	9	100	DKB0760

s = strip length

Through connectors 0.75 - 10 mm²

■ Data: Cu 99.95%, tin plated

■ Cable inspection hole, for stranded (class 2) and flexible (class 5) Cu conductors.

■ UL-approved.



AWG	mm ²	Cat. no.	mm d	L	s	Pcs/ pack	Rec. tool
(22)-18	0,75	KS0,75	1,3	14,0	7	100	DKB0760
(18)-16	1,5	KS1,5	1,8	14,0	7	100	DKB0760
(16)-14	2,5	KS2,5	2,3	16,0	8	100	DKB0760
12	4	KS4	3,0	19,0	9	100	GWB4099, ES2258
10	6	KS6	4,0	19,0	9	100	GWB4099, ES2258
8	10	KS10	5,0	30	16	100	GWB4099, ES2258
8		KST10	4,5	30	16	100	GWB4099

s = strip length

Receptacles 0.5 - 6 mm²

■ Data: brass, tin plated.



mm ²	Cat. no.	mm e	t	L	For tabs	s	Pcs/ pack	Rec. tool
0,5-1	B1003FLS5	6,0	0,25	14,0	2,8x0,5	7	100	DRB0115
	B1003FLS8	5,0	0,3	12,7	2,8x0,8	7	100	DRB0115
0,75-1,5	B1505FLS5-1	6,4	0,4	16,0	4,8x0,5	7	100	GRB0560
	B1505FLS8-1	6,4	0,4	16,0	4,8x0,8	7	100	GRB0560
	B1507FLS1	7,6	0,4	19,0	6,3x0,8	7	100	GRB0560
1,5-2,5	B2505FLS5	6,0	0,35	15,6	4,8x0,5	8	100	GRB0560
	B2505FLS8	6,0	0,4	16,0	4,8x0,8	8	100	GRB0560
	B2507FLS1	7,6	0,4	19,0	6,3x0,8	8	100	GRB0560
4-6	B4607FLS1	7,6	0,4	19,0	6,3x0,8	8	100	GRB0560

t = palm thickness s = strip length

For detailed information regarding recommended tool, see tool section at the end of this chapter.

**Receptacles with locking lip 0.5 - 6 mm²**

■ Data: brass, tin plated.



mm ²	Cat. no.	mm e	t	L	For tabs	s	Pcs/ pack	Rec. tool
0,5-1,5	B1507FLSN	7,5	0,4	19,2	6,3x0,8	7	100	GRB0560
1,5-2,5	B2507FLSN	7,5	0,4	19,0	6,3x0,8	8	100	GRB0560
4-6	B4607FLSN	7,5	0,4	19,0	6,3x0,8	9	100	GRB0560

t = metal thickness s = strip length

Multiple tabs 0.5 - 2.5 mm²

■ Data: brass, tin plated.



mm ²	Cat. no.	mm e	t	L	For tabs	s	Pcs/ pack	Rec. tool
0,5-1,5	B1507FLSH	8,0	0,4	20,0	6,3x0,8	7	100	GRB0560
1,5-2,5	B2507FLSH	8,0	0,4	20,0	6,3x0,8	7	100	GRB0560

t = metal thickness s = strip length

Receptacle, 90°, 0.5 - 1.5 mm²

■ Data: brass, tin plated.



mm ²	Cat. no.	mm e	t	L	For tab	s	Pcs/ pack	Rec. tool
0,5-1,5	B1507FLSB8	7,7	0,4	13,0	6,3x0,8	7	100	TRB0515B

t = metal thickness s = strip length

Receptacle 90°, 0.5 - 1 mm²

■ Data: brass, tin plated.



mm ²	Cat. no.	mm e	t	L	For tabs	s	Pcs/ pack	Rec. tool
0,5-1	B1003FLSV5	4,9	0,3	9,3	2,8x0,5	7	100	DRB0115

t = metal thickness s = strip length

For detailed information regarding recommended tool, see tool section at the end of this chapter.



Tabs 0.5 - 2.5 mm²

■ Data: brass, tin plated.



mm ²	Cat. no	mm e	L	Tabs	s	Pcs/ pack	Rec. tool
0,5-1	B1003H	5,6	12,7	2,8x0,8	7	100	DRB0115
0,5-1,5	B1507H	8,0	19,0	6,3x0,8	7	100	GRB0560
1,5-2,5	B2507H	8,0	20	6,3x0,8	8	100	GRB0560

s = strip length

Tabs with locking lip 0.5 - 6 mm²

■ Data: brass, tin plated.



mm ²	Cat. no.	mm e	L	Tabs	s	Pcs/ pack	Rec. tool
0,5-1,0	B1007HN	16,0	28	6,3x0,8	8	100	DRB0115
1,5-2,5	B2507HN	16,0	28	6,3x0,8	8	100	GRB0560
4-6	B4607HN	16,0	28	6,3x0,8	9	100	GRB0560

s = strip length

Bullets 0.2 - 1.5 mm²

■ Data: brass, tin plated.

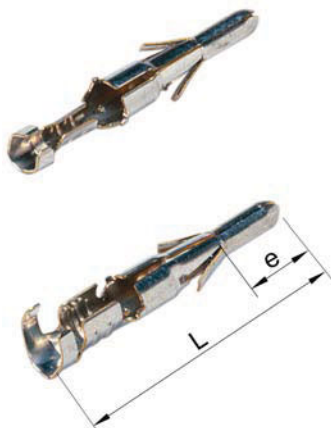

mm ²	Cat. no	mm e	L	Ø bullet	s	Pcs/ pack	Rec. tool
0,2-0,5	B0502HA	5,5	21	2,0	7	100	DRB0115
0,5-1,5	B1502HA	5,5	21	2,0	8	100	DRB0115

s = strip length

Sockets 0.2 - 1.5 mm²

■ Data: brass, tin plated.



mm ²	Cat. no.	mm e	L	For bullet Ø	s	Pcs/ pack	Rec. tool
0,2-0,5	B0502HO	5,5	21	2,0	7	100	DRB0115
0,5-1,5	B1502HO	5,5	21	2,0	8	100	DRB0115

s = strip length

For detailed information regarding recommended tool, see tool section at the end of this chapter.



Tabs

■ Data: brass, tin plated.

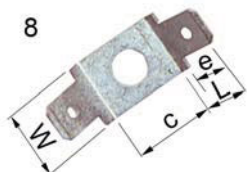
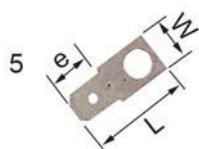
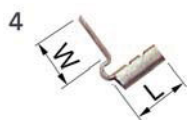
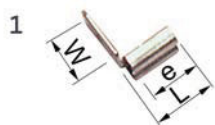

Fig	Cat. no.	mm W	e	L	Tabs	Pcs/ pack
1	B07FLS1H	8,5	8,0	8,5	6,3x0,8	100
2	B07FLS2H	9,0	7,5	18,5	6,3x0,8	100
3	B07FLS3H	8,0	7,5	21	6,3x0,8	100

Fig	Cat. no.	mm W	L	Tabs	Pcs/ pack
4	B07FLS	7,5	9,0	6,3x0,8	100

Fig	Cat. no.	mm W	e	∅	L	Tabs	Pcs/ pack
5	B1807H4	8,1	8,3	4,4	19,1	6,3x0,8	100
5	B1807H5	8,0	8,3	5,4	19,2	6,3x0,8	100

Fig	Cat. no.	mm b	e	∅	c	Tabs	Pcs/ pack	Angle
6	B0457H4	8,0	8,0	4,1	8,0	6,3x0,8	100	45°
6	B0457H5	8,0	8,0	5,3	8,0	6,3x0,8	100	45°
7	B0907H4	8,0	8,3	4,1	8,0	6,3x0,8	100	90°
7	B0907H5	8,0	8,0	5,3	8,0	6,3x0,8	100	90°

Fig	Cat. no.	mm W	c	e	∅	L	Tabs	Pcs/ pack	Angle
8	B2457H4	10,0	12,0	8,0	4,2	10,0	6,3x0,8	100	2x45°
8	B2457H5	10,0	12,0	8,0	5,2	10,0	6,3x0,8	100	2x45°

∅ hole diameter.

3



Tabs for soldering

■ Data: brass, tin plated.

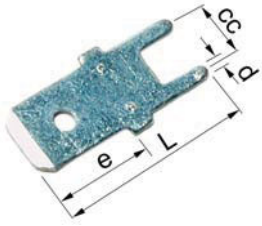

Cat. no.	mm cc	e	d	L	Tabs	Pcs/ pack
12523	5,0	8,0	1,5	16,8	6,3x0,8	100



Cat. no.	mm cc	d	W	L	Tabs	Pcs/ pack
17127	5,0	1,3	5,0	13,4	2,8x0,8	100
17128	5,0	1,2	9,0	16,0	6,3x0,8	100

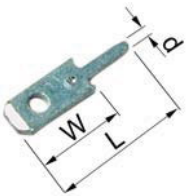

Cat. no.	mm d	W	L	Tabs	Pcs/ pack
12610	0,9	6,5	10,5	2,8x0,8	100



Insulation boots

■ Data: used together with straight and angled receptacle connections.

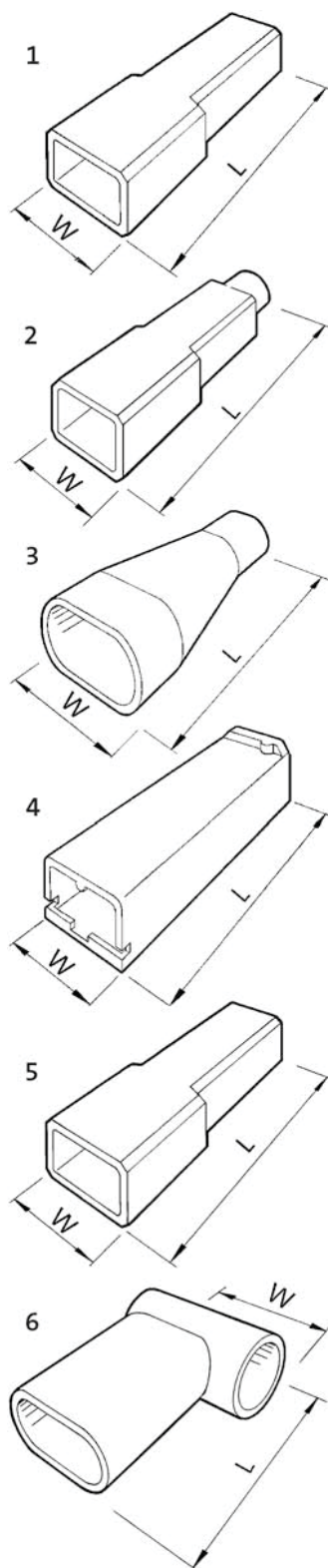

Fig.	Cat. no.	mm L W	Material Colour	mm Tab size Max. cable Ø	Pcs/ pack	Temp °C
1	ISO1003FL1	19,0 5,6	PE transp	2,8 2,5	100 100	-50 +85
2	ISO1005FL1	21,0 7,6	PVC transp	4,8 3,2	100 100	-25 +75
3	ISO1507HBW6	23 11,0	PVC transp	6,3 3,6	100 100	-25 +75
4	ISO1507FLS	24 9,0	PE transp	6,3 2,5	100 100	-25 +75
5	ISO2507FLS1	22,5 9,5	PE transp	6,3 3,0	100 100	-50 +85
6	ISO1507FLB*	17,3 15,0	PVC transp	6,3 2,5	100 100	-25 +75

* Used with 90° receptacle



Connector blocks

- used with receptacles and tabs with locking lip 1,5 - 6 mm²
- material PA (nylon) transparent
- max voltage 250 VAC

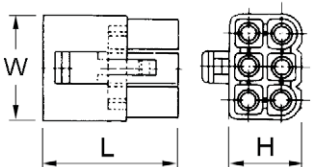
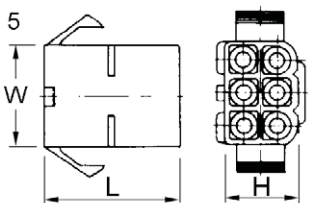
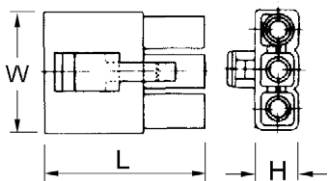
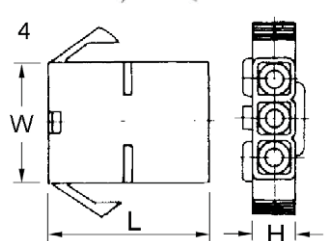
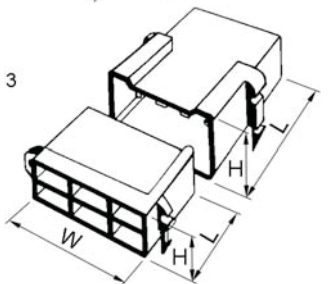
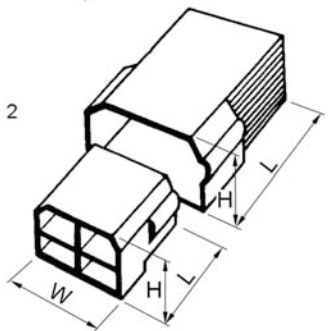
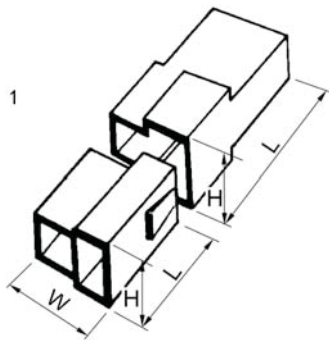

Fig	Cat. no.	No. of terminals	mm L	W	H	Pcs/ pack	Note
1	408-2-M	2	24	16,4	9,7	100	1
2	408-4-M	4	24	28	15,3	100	1
3	408-6-M	6	29	29	15,2	100	1
-	408-8-M	8	34	38	15,6	100	1
1	408-2-F	2	32	20	12,7	100	2
2	408-4-F	4	33	23	17,4	100	2
3	408-6-F	6	33	31	18,7	50	2
-	408-8-F	8	33	40	18,6	25	2

Note

- 1 Used with receptacles B2507FLSN and B4607FLSN.
- 2 Used with tabs B2507HN and B4607HN.

Connector blocks

- used together with sockets and bullets 0,2 - 1,5 mm²
- material PA (nylon) transparent
- rated voltage 250 VAC
- max current 20 A
- temperature range -20° C to +105° C

Fig	Cat. no.	Pol	mm L	W	H	Pcs/ pack	Note
-	MC02F	2	27	13,6	7,3	100	3
-	MC02M	2	27	13,5	7,3	100	4
4	MC03F	3	27	19,6	7,2	100	3
4	MC03M	3	27	19,6	7,1	100	4
-	MC04F	4	27	13,5	13,5	100	3
-	MC04M	4	27	13,5	13,5	100	4
5	MC06F	6	27	19,6	13,4	100	3
5	MC06M	6	27	19,6	13,4	100	4
-	MC09F	9	27	19,7	19,7	100	3
-	MC09M	9	27	19,7	19,7	100	4
-	MC12F	12	27	26	19,6	50	3
-	MC12M	12	27	26	19,7	50	4
-	MC15F	15	27	32	19,6	50	3
-	MC15M	15	26	32	19,9	50	4

Note

- 3 Used with bullets B0502HA and B1502HA.
- 4 Used with sockets B0502HO and B1502HO.



Connector blocks

- used together with receptacles
- material PVC semi-transparent
- max voltage 400 V
- max current 18 A

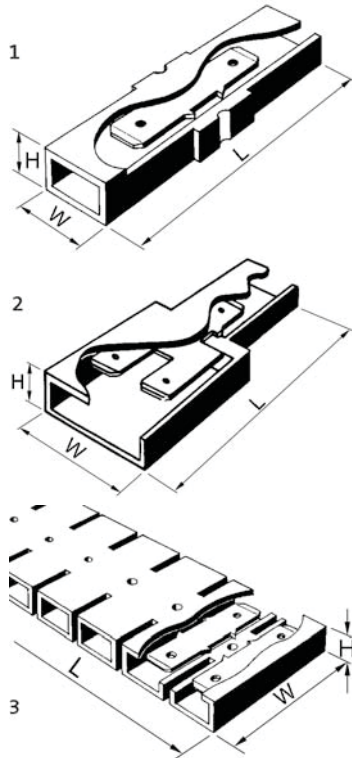

Fig	Cat. no.	No. of links	mm L	W	H	Tabs	Pcs/ pack
1	404-1	1	48	12,0	6,0	6,3x0,8	100
2	405-3	1+2	54,5	20,7	7,4	6,3x0,8	100
3	401-12	12	147	28	7,0	6,3x0,8	50



Assortment box PL701

Elpress assortment box designed for field service engineers and service departments.

Included:

- manufactured from polyeten
- 19 partions
- 700 un-insulated terminals and through connectors 0.75 - 10 mm²
- crimp tool DKB0325
- crimp tool GWB4099 Miniforce
- stripping and cutting tool SCT001
- weight 4.3 kg, length 370 mm, width 298 mm, height 36.5 mm



Hobby tools for crimping terminals 0.5 - 6 mm² and for cutting and stripping

Technical data:

- manufactured from high-class steel and with semi-soft handles
- die nests are distinctly marked
- no full closure ratchet
- cuts up to 6 mm²
- strips up to 6 mm²
- bolt-cutter M2,5 - M5
- weight 0.20 kg, length 225 mm

Crimp range 0.5 - 6 mm²

T50

Elpress hobby tool.

Particulars:

- crimps pre-insulated terminals 0.5 - 6 mm² and indent crimps un-insulated, closed barrel terminals 1.5 - 6 mm²
- red, semi-soft handles for optimal comfort
- stripping and bolt cutting functions

T50



Crimp types

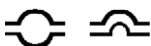

Area	Cat. no.	Crimp type	Weight	Length
0.5-6 mm ²	T50	oval/indent	0.200 kg	225 mm

T51

Elpress hobby tool.

Particulars:

- crimps pre-insulated terminals 0.5 - 6 mm², and roll crimps open barrel un-insulated terminals 0.5 - 2.5 mm²
- yellow, semi-soft handles for optimal comfort
- stripping and bolt cutting functions

T51



Crimp types

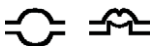

Area	Cat. no.	Crimp type	Weight	Length
0.5-6 mm ²	T51	oval/roll	0.200 kg	225 mm

T52

Elpress hobby tool.

Particulars:

- roll crimps un-insulated, open barrel, un-insulated terminals 0.5 - 6 mm²
- green, semi-soft handles for optimal comfort
- stripping and bolt cutting functions

T52

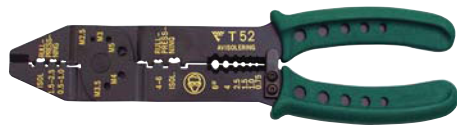

Crimp type



Area	Cat. no.	Crimp type	Weight	Length
0.5-6 mm ²	T52	roll	0.200 kg	225 mm



Certified tools for un-insulated terminals 0.15 - 6 mm²



Technical data:

- die nests are distinctly marked
- adjustable if changes occur, ie after many crimps
- tested with Elpress terminals
- ratchet system to guarantee fully closed crimps
- emergency release if the crimping sequence must be interrupted
- unique design makes the tools compact and handy
- requires minimum of muscle strength for a perfect crimp
- at least 50.000 crimps
- delivered with certificate for quality assurance

3

TRB0515B



Crimp type



Crimp range 0.5 - 1.5 mm²

TRB0515B

Tool for roll crimping of flag terminal B1507FLSB8.

- certificate not included

Area	Cat. no.	Crimp type	Weight	Length
0.5-1.5 mm ²	TRB0515B	roll	0.740 kg	260 mm

DRB0115



Crimp type



Crimp range 0.15 - 1.5 mm²

DRB0115

Elpress crimp tool for roll crimping of un-insulated receptacles, tab terminals, bullets and sockets. For crimping of B1507FLS1 or B1507FLSH GRB0560/GRB0560C should be used.

Area	Cat. no.	Crimp type	Weight	Length x Width
0.15-1.5 mm ²	DRB0115	roll	0.444 kg	192 x 66 mm

DKB0325



Crimp type



Crimp range 0.25 - 2.5 mm²

DKB0325

Elpress crimp tool for indent crimping of Cu tube and sheet terminals.

Area	Cat. no.	Crimp type	Weight	Length x Width
0.25-2.5 mm ²	DKB0325	indent	0.444 kg	192 x 66 mm

DKB0760



Crimp type



Crimp range 0.75 - 6 mm²

DKB0760

Elpress crimp tool for indent crimping of Cu tube and sheet terminals.

Area	Cat. no.	Crimp type	Weight	Length x Width
0.75-6 mm ²	DKB0760	indent	0.445 kg	192 x 66 mm



Certified Miniforce tools for un-insulated terminals 0.5 - 10 mm²



Technical data:

- unique mechanism that reduces maximum handle force with 30% compared to the earlier Exx version
- ratchet system to guarantee a fully closed crimp
- release mechanism if the crimping sequence must be interrupted
- distinctly marked die nests
- adjustable if changes occur, ie after many crimps
- tested with Elpress terminals
- ergonomically designed handles to fit all users
- optimises the crimp quality
- reduces the risk for repetitive strain injuries (RSI)
- light and handy design without reduction in durability
- type C has extra long handles for comfortable two-hand grip
- at least 80.000 crimps
- delivered with certificate for quality assurance

Crimp range 0.5 - 6 mm²

GRB0560L and GRB0560LC

Elpress Miniforce crimp tools for roll crimping of un-insulated terminals.

Type L crimp tools are supplied with **three exchangeable locators** for receptacle terminals (see table).

Type LC has **locators** and long handles.

Particulars:

- supplied in a practical and rigid plastic box
- the L and LC type tool has locators - your "third hand" - to hold the terminals in the right crimp position, which simplifies quality performance considerably

GRB0560L



GRB0560LC



Crimp type

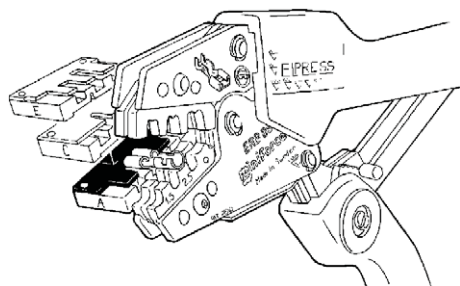

GRB0560-locator.

Locator	Marking	
A	1.	B1507FLS1 B1507FLSN
	2.	B2507FLS1 B2507FLSN
	3.	B4607FLSN B4607FLS1
C	1.	B1507H
	2.	B2507HN
	3.	B4607HN
E	1.	B1505FLS (5 or 8) -1
	2.	B2505FLS (5 or 8) -1

Area	Cat. no.	Crimp type	Weight	Length x Width
0.5-6 mm ²	GRB0560L	roll	0.952 kg	220 x 72 mm
0.5-6 mm ²	GRB0560LC	roll	0.986 kg	255 x 72 mm



GRB0560



GRB0560C



Crimp type



GRB0560 and GRB0560C

Elpress Miniforce crimp tool for roll crimping of un-insulated terminals. Similar to GRB0560C and GRB0560LC but without locators or carry box.

Area	Cat. no.	Crimp type	Weight	Length x Width
0.5-6 mm ²	GRB0560	roll	0.649 kg	220 x 72 mm
0.5-6 mm ²	GRB0560C	roll	0.684 kg	255 x 72 mm

Crimp range 4 - 10 mm²

GWB4099 and GWB4099C

Miniforce crimp tools for W-indent crimping of un-insulated, closed barrel ring, fork, pin and tube terminals and connectors as well as tube terminals and through connectors type KR and KS.

Type C with long handles.

GWB4099



GWB4099C



Crimp type



Area	Cat. no.	Crimp type	Weight	Length x Width
4-10 mm ²	GWB4099	W-crimp	0.635 kg	220 x 72 mm
4-10 mm ²	GWB4099C	W-crimp	0.674 kg	255 x 72 mm

GWB4010 and GWB4010C

Miniforce crimp tools for W-indent crimping of un-insulated terminals type KR/KRT og KS/KST.

Type C with long handles.

GWB4010



Crimp type



Area	Cat. no.	Crimp type	Weight	Length x Width
4-10 mm ²	GWB4010	W-crimp	0.418 kg	203 x 76 mm
4-10 mm ²	GWB4010C	W-crimp	0.478 kg	256 x 80 mm



Elpress Mobile - a tool with interchangeable dies



Professional crimp tool with interchangeable dies for electrical installations and data-com.

Technical data:

- a reliable, safe, economical and comfortable tool
- parallel-action stroke with a maximum force of 10 000 N, tested for 20000 crimps
- easily interchangeable crimp dies with one handgrip
- the dies are kept together as pairs with a special rod to simplify handling
- a wide range of crimping dies enables the user to cover 20-30 applications in just one tool frame

You purchase Elpress Mobile in four basic versions:

Elpress Mobile

Mobile handtool (only the frame). Dies supplemented.

Cat. no.	Weight	Length x Width
Elpress Mobile	0.554 kg	234 x 64 mm



Mobile, only the frame.

Mobile Installation

Mobile hand tool and two interchangeable dies:

- die OAA0525 for crimping of insulated terminals 0.5 - 2.5 mm²
- die OEB0210 for crimping of end sleeves 0.25 - 10 mm²
- the tool is delivered with dies in a plastic packaging

Cat. no.	Weight	Length x Width
Mobile Installation	0.694 kg	234 x 64 mm



Mobile + dies OAA0525 and OEB0210.



Mobile + dies OMP45 and OCC1113.

Mobile DataCom

Mobile hand tool and two interchangeable dies:

- die OMP45 for crimping of modular plug, RJ45 contacts
- die OCC1113 for crimping of coaxial contacts RG58, 59, 62, 71
- the tool is delivered with dies in a plastic packaging

Cat. no.	Weight	Length x Width
Mobile DataCom	0.659 kg	234 x 64 mm



Mobile + dies OMS4, OMS3 and OMSL

Mobile Solar Kit

Mobile hand tool for Solar panel installations including tool, three interchangeable dies and cable stripper LOKE for solar panel cable with extra thick insulation.

- OMS4, for crimping of Solar type connectors \varnothing 4 mm, with open barrel conductor crimp 2.5-6.0 mm²
- OMS3, for crimping of Solar connectors \varnothing 3 mm, turned pin type 2.5 - 6.0 mm²
- OMSL, for crimping of Solar connectors, turned pin type, Solar Lock 2.5 - 6.0 mm²

Cat. no.	Weight	Length x Width
Mobile Solar Kit	0.722 kg	234 x 64 mm



Cable stripper LOKE.

Mobile Box

Box for the Mobile tool which has place for the tool and 5-6 dies. The Mobile tool and dies are ordered separately.

Cat. no.	Weight	Length x Width	Height
Mobile Box	0.320 kg	246 x 218 mm	56.5 mm



Additional dies to Elpress Mobile are presented in the table on the following page.



You complete your kit with these dies

Additional dies to Elpress Mobile. All dies have the same easy and fast fastening in the frame. The dies are kept together as pairs and delivered in a plastic cassette which can be put together with other cassettes.



OAA0160
For crimping of pre-insulated terminals 0.1 - 0.5 & 4 - 6 mm².



OAA0525
For crimping of pre-insulated terminals 0.5 - 2.5mm².



OSW0360
For crimping of through connectors with heat shrink insulation 0.3-0.75 and 4-6 mm²



OSW0525
For crimping of through connectors with heat shrink insulation 0.5-1.5 and 1.5-2.5 mm²



OPB0140
For crimping of global power connectors, GPC.



OPB6099
For crimping of global power connectors, GPC.



OWB4099
For W-crimping of un-insulated terminals 4 - 10 mm².



OKB0725
For indent crimping of un-insulated terminals 0.75 - 2.5 mm².



OKB0560
For indent crimping of un-insulated terminals 0.5 - 6 mm².



OEB0210
For crimping of end terminals 0.25 - 10 mm².



OEB1625
For crimping of end terminals 16 - 25 mm².



OEB3550
For crimping of end terminals 35 - 50 mm².



ORB0110
For roll crimping of terminals 0.1 - 1.0 mm².



ORB0560
For roll crimping of terminals 0.5 - 6 mm².



OMP45
For crimping of modular-plug RJ45.



OMP11
For crimping of modular-plug RJ11.



OFO5432
For crimping of fiber optics connections type ST, SC, SMA, SMB, SFR.



OCC0908
For crimping of coaxial contacts type BNC, TNC, RG174, RG179.



OCC1113
For crimping of coaxial contacts type BNC, TNC, RG58, RG59, RG62, RG71.



OCC4755
For crimping of coaxial contacts type CATV, RG6, RG59.



OMS4
For crimping of solar connectors Ø 4 mm, with open barrel conductor crimp 2.5 - 6.0 mm².



OMS3
For crimping of solar connectors Ø 3 mm, turned pin type 2.5- 6.0 mm².



OMSL
For crimping of solar connectors turned pin type Solar Lock 2.5- 6.0 mm².





Battery powered crimp tool



PV130P, PV130S - Elpress Mini.

Technical data:

- NiMh battery power (9.6 V and 1.3 Ah), recharge time approx. 40 minutes
- advanced ergonomics for excellent access in confined areas
- tool for service and installation work
- fast crimping 2-4 seconds
- approx. 150 crimps per charge
- crimp ranges see table below
- supplied in a plastic case with battery charger and one battery

Crimp range 0.5-6, 0.25-10, 0.5-50 mm²

PV130P - Elpress Mini

Battery powered tool for parallel action crimping of pre-insulated terminals up to 6 mm², un-insulated terminals up to 10 mm² and end terminals up to 50 mm².

Included:

- Battery: PVBP1-MH
- Charger: PVBC2

Area	Cat. no.	Weight	Length
0.5-6/0.25-10/0.5-50 mm ²	PV130P - Elpress Mini	1.3 kg	360 mm



PV130P, box and charger.

PV130S - Elpress Mini

Battery powered tool for scissor crimping movement of pre-insulated terminals up to 6 mm², un-insulated terminals up to 10 mm² and end terminals up to 50 mm².

Included:

- Battery: PVBP1-MH
- Charger: PVBC2

Area	Cat. no.	Weight	Length
0.5-6/0.25-10/0.5-50 mm ²	PV130S - Elpress Mini	1.5 kg	360 mm



EB0560

WB4099

KB0325



EB3550

EB1025

EB4010



RB0560

Die table

	PV130P	PV130S
Application	Die	Die
Pre-insulated 0.5-6 mm ²	SA0760	SA0760
Un-insulated, indent crimp 0.25-2,5 mm ²	KB0325	KB0325
Un-insulated, W crimp 4-10 mm ²	WB4099	WB4099
Un-insulated, roll-crimp 0.5-6 mm ²	RB0560	RB0560
End terminals (ferrules)		
0.5-6 mm ²	EB0560	EB0560
4-10 mm ²	EB4010	EB4010
10-25 mm ²	EB1025	EB1025
35-50 mm ²	EB3550	EB3550

Remember to specify dies when you order a tool.



Tool for Cu terminals 4 - 16 mm²

Crimp range 4 - 16 mm²

Particulars:

- certified tool for norm accordance connection
- 30% lower handforce than earlier T2258 version makes the crimping easier
- ergonomic handles makes the installation easier
- scissor movement for optimal access in narrow spaces
- ratchet release which is not released until the crimping is completed
- hexagonal crimping with clearly marked crimping dies
- possibility to adjustment at calibration after long time use

ES2258

Certified crimping tool for crimping of Cu-terminals, CUT 6-16 mm² and KR/KS 4-10 mm². **ES2258 replaces T2258.**

Particulars:

- weight 0.65 kg, length 300 mm

ES2258



Crimp type





Cu terminals and connectors 0.75 - 1000 mm²

General information	2
Tube terminals 0.75 - 10 mm ²	4
Tube terminals 16 - 800 mm ² , KRF, and 500 - 1000 mm ² , KRD	5
Tube terminals 10 - 1000 mm ² , KRT	7
Tube terminals 16 - 1000 mm ² , KRD	9
Cu terminals 50 - 240 mm ² , KRFN, with narrow palm	10
Tube terminals with two stud holes 35 - 400 mm ² , KRF	11
Tube terminals 45°, 10 - 150 mm ² , KRF	12
Tube terminals 45°, 10 - 120 mm ² , KRT	13
Tube terminals 90° degrees 10 - 150 mm ² , KRF	14
Tube terminals 90° degrees 10 - 120 mm ² , KRT	15
Tube terminals 10 - 300 mm ² DIN 46235	16
Sheet metal terminals 10 - 240 mm ² DIN 46234	17
Through connectors 0,75 - 800 mm ² , KS/KSF	18
Through connectors 10 - 800 mm ² , KST	19
Through connectors 16 - 800 mm ² , KSD	19
Through connectors with partition 10 - 400 mm ²	20
Parallel connectors for total cross section areas 0.5 - 7.5 mm ²	20
Connectors for solid Cu conductors 6 - 16 mm ²	20
Pin terminals 10 - 95 mm ² DIN 46230	21
Connectors for Ericsson Cables Excel and Fxcel type 10 - 16 mm ²	21
Branch connectors (C-sleeves) 6 - 300 mm ²	22
Application table for C-sleeves (side feed only)	23



General information about Cu terminals

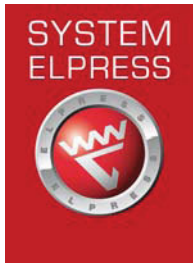

System Elpress

System Elpress consists of connectors and tools tested together for optimum connection result. The System concept makes you as a customer able to feel secure when using our system and to be sure a safe connection is made when Elpress products are used correctly.

Cu-connections

Elpress Cu-connections are produced from electrolytic 99.9% copper. Terminals and through connectors exist in a large variety of types for stranded as well as for flexible conductors. C-sleeves for earth conductor branch off also come in a large number of sizes. If a standard type is not suitable, we produce tailor made designs specific to the application.

KR/KRF terminals and KS/KSF connectors may be used for both stranded and flexible conductors.

KRD terminals and KSD connectors are used for stranded conductors.

KRT terminals and KST connectors equal the German "Standard types" (not DIN!) and are used for stranded conductors.

C-sleeves are used for branch-off or cross connections for mainly earth conductors such as for lightning protection and earthing grids.

By crimping Elpress terminals and connectors with Elpress crimp tools, connections are achieved that meet the requirements of SEN 245010, BS 4579:1, VDE 0220:1, EN-IEC 61238:1 whichever is applicable.



UL approved terminals

UL is an American standard which is also internationally accepted. Elpress standard Cu terminals of types KR/KS, KRF/KSF and KRT/KST, are UL approved according to no. E205350. Cu terminals of types

KR/KS, KRF/KSF are for stranded and flexible copper wires, classes 2 and 5 according to IEC 60228, and have a working area of 1-500 mm².

Cu terminals of types KRT/KST is used for stranded copper wires 10-500 mm².



DNV approved

Elpress KRF/KSF, KRT/KST terminals comply with DNV's rules for the classification of ships and Det Norske Veritas' Offshore Standards. The terminals are approved for installations on ships and mobile offshore units.

Number of crimps

Normally only one crimp per conductor end is needed up to and including 150 mm² and two crimps for larger areas. For detailed information reg no. of crimps, see tables for dies/tools. If possible multiple crimps should be positioned with a few mm distance from each other and from the neck end. In many cases however, overlapping crimps have to be made for space reasons.

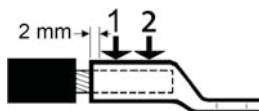

Crimp sequence with two adjacent crimps.

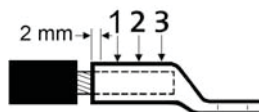

Crimp sequence with three adjacent crimps.

Markings on Cu-connections

Elpress marking system for Cu-connectors shows logotype, conductor area and ID-number for crimp die to be used. This system enables final inspection of proper die use as the die number is automatically imprinted by the die on the crimped barrel.



Marking of tube terminals	
32	(on the terminal neck)
ID-no.	for the hexagonal die
(Elpress logo) 300-16F	(on the palm)
300	= Cu-conductor area, mm ²
16	= hole for screw M16
F	= KRF



Marking of connectors	
(Elpress logo) 27	
ID-no.	for hexagonal die
185 F	(possible screen area and an earth-sign)
185	= Cu-conductor area, mm ²
F	= KSF



Marking of tap-off C-sleeves	
120 - 150/70 - 95	
120 - 150	= Cu-wire range, mm ²
70 - 95	= Cu-wire range, mm ²
(Elpress logotype) C16 - 13	Cat.no.



Stud holes in terminal palms

Screw-dimension	Hole diameter tolerance H13 (∅ mm)
M 3	3,2
M 4	4,3
M 5	5,3
M 6	6,4
M 8	8,4
M 10	10,5
M 12	13
M 16	17
M 20	21
M 24	25

Screws and washers

The following apply to bright galvanized nuts and screws in strength class 8.8 used for connecting terminals to Cu and Al bus bars:

- Always use a torque wrench to ensure that they are tightened to the right torque. Ensure it is regularly calibrated in accordance with the supplier's instructions.
- Use the recommended torque in accordance with the screw manufacturer's instructions.
- Always use a hard flat washer to reduce friction between the installation surface and hole edge pressure, min hardness HB200.
- A spring washer in accordance with DIN 6796 may be used together with a flat washer to further increase strength in advanced applications.
- Assemble as shown in image.

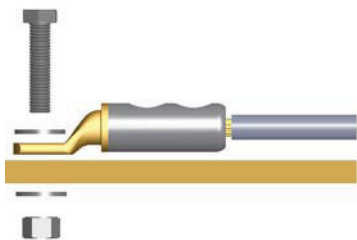

Screw	Tightening torque (Nm)
M5	5
M6	9
M8	21
M10	41
M12	70
M14	110
M16	170
M20	340

EasyGuide

- to easily insert flexible conductors into the terminal

EasyGuide consists of a stand (EG-TS) and tapered inserts (EG-xx) which are chosen to fit the terminal size. Place the terminal in the guiding groove on one side of the insert and introduce the conductor from the other side, open the insert halves and remove the terminal with the conductor in place.

Finally a simple way to get all the strands into the barrel! Suits Elpress type - KRF terminals and connectors from 6 to 240 mm².

Inserts	
6 mm ²	EG 6
10 mm ²	EG 10
16 mm ²	EG 16
25 mm ²	EG 25
35 mm ²	EG 35
50 mm ²	EG 50
70 mm ²	EG 70
95 mm ²	EG 95
120 mm ²	EG 120
150 mm ²	EG 150
185 mm ²	EG 185
240 mm ²	EG 240



EasyGuide.



Customized products

A customized product is an important part of our work. It is a special challenge to solve problems for customers while producing products profitably. In this way, we also have our knowledge of customer needs. Among these connectors include different models of T-connectors where you can connect three conductors

of the same size by using only one connection. These are used for example in transformer manufacturing. Other connections in the transformer manufacturing is the terminal for tap changers and lead-through terminals. In summary, all connections are designed to be an easy way to ensure a high quality crimped connection even in advanced applications.



Tube terminals 0.75 - 10 mm²

- Data: Cu 99.95%, tin plated
- Cable inspection hole, for flexible (class 5) and stranded (class 2) Cu-conductors.
- UL-approved (1-10 mm²).

Marking example KR: 10 10

10 = mm² 10 = palm hole for M10



AWG	mm ²	Cat. no.	Screw	mm W	d	t	L	s	Pcs/ pack	Rec. tool
(22)-18	0,75	KR0,75-3*	M3	6,0	1,3	0,8	16,0	7	100	DKB0760
(22)-18		KR0,75-4*	M4	6,0	1,3	0,8	17,0	7	100	DKB0760
(18)-16	1,5	KR1,5-3*	M3	6,5	1,8	1,0	16,0	7	100	DKB0760
(18)-16		KR1,5-4*	M4	6,5	1,8	1,0	17,0	7	100	DKB0760
(18)-16		KR1,5-5*	M5	7,5	1,8	0,8	18,0	7	100	DKB0760
(16)-14	2,5	KR2,5-3*	M3	7,5	2,3	1,3	17,0	8	100	DKB0760
(16)-14		KR2,5-4*	M4	7,5	2,3	1,3	18,0	8	100	DKB0760
(16)-14		KR2,5-5*	M5	8,5	2,3	1,2	19,0	8	100	DKB0760
(16)-14		KR2,5-6*	M6	8,5	2,3	1,1	19,0	8	100	DKB0760
12	4	KR4-4	M4	8,5	3,0	1,5	21	9	100	GWB4099, ES2258
12		KR4-5	M5	9,0	3,0	1,5	22	9	100	GWB4099, ES2258
12		KR4-6	M6	10,0	3,0	1,4	23	9	100	GWB4099, ES2258
10	6	KR6-4	M4	9,5	4,0	1,7	22	9	100	GWB4099, ES2258
10		KR6-5	M5	9,5	4,0	1,7	22	9	100	GWB4099, ES2258
10		KR6-6	M6	10,0	4,0	1,6	23	9	100	GWB4099, ES2258
10		KR6-8	M8	13,0	4,0	1,2	30	9	100	GWB4099, ES2258
8	10	KR10-5	M5	11,5	5,0	3,0	29	11	100	GWB4099, ES2258
8		KR10-6	M6	11,5	5,0	3,0	29	11	100	GWB4099, ES2258
8		KR10-8	M8	13,5	5,0	2,2	33	11	100	GWB4099, ES2258
8		KR10-10	M10	16,0	5,0	2,0	34	11	100	GWB4099, ES2258
8		KR10-12	M12	19,0	5,0	1,7	41	11	100	GWB4099, ES2258

t = palm thickness s = strip length
* without inspection hole

For detailed information regarding recommended tool or system, see chapter 6.



Tube terminals 16 - 800 mm², KRF, and 500 - 1000 mm², KRD

- Data: electrolytic copper, tin plated.
- Cable inspection hole, for stranded (class 2) and flexible (class 5) Cu-conductors.
- UL-approved (KRF 16-500 mm²). DNV-approved (KRF 16-400 mm²).

Marking example KRF: 70 10F, KRD: 500 16 (Elpress logotype included)

70 = mm² 10 = palm hole for M10 F = type KRF, for stranded and flexible conductors
 500 = mm² 16 = palm hole for M16

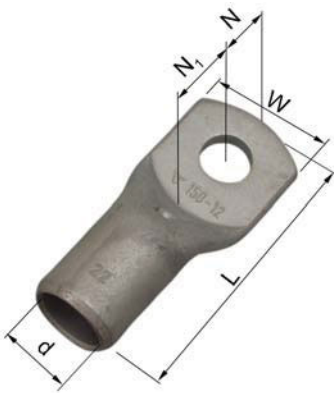

AWG	Cat. no. mm ² - bolt hole M	mm W	d	N	N ₁	L	Pcs/ pack	Die no.	Rec. tool
6	KRF16-6	13,0	6,0	8,0	9,0	34	100	9	V600, V1300
6	KRF16-8	13,0	6,0	8,0	9,0	34	100	9	V600, V1300
6	KRF16-10	16,0	6,0	10,0	11,0	38	100	9	V600, V1300
6	KRF16-12	22	6,0	12,0	13,0	47	100	9	V600, V1300
4	KRF25-6	16,0	8,0	8,0	10,0	39	100	11	V600, V1300
4	KRF25-8	16,0	8,0	8,0	10,0	39	100	11	V600, V1300
4	KRF25-10	17,0	8,0	10,0	11,0	42	100	11	V600, V1300
4	KRF25-12	22	8,0	12,0	13,0	47	100	11	V600, V1300
2	KRF35-6	18,0	9,0	10,0	11,0	47	100	13	V600, V1300
2	KRF35-8	18,0	9,0	10,0	11,0	47	100	13	V600, V1300
2	KRF35-10	18,0	9,0	10,0	11,0	47	100	13	V600, V1300
2	KRF35-12	22	9,0	12,0	14,0	52	100	13	V600, V1300
1/0	KRF50-6	21	11,0	11,0	12,0	50	100	14,5	V600, V1300
1/0	KRF50-8	21	11,0	11,0	12,0	50	100	14,5	V600, V1300
1/0	KRF50-10	21	11,0	11,0	12,0	50	100	14,5	V600, V1300
1/0	KRF50-12	21	11,0	12,0	14,0	53	100	14,5	V600, V1300
1/0	KRF50-16	27	11,0	15,0	17,0	59	100	14,5	V600, V1300
2/0	KRF70-6	25	13,0	11,0	12,0	55	50	17	V600, V1300
2/0	KRF70-8	25	13,0	11,0	12,0	55	50	17	V600, V1300
2/0	KRF70-10	25	13,0	11,0	12,0	55	50	17	V600, V1300
2/0	KRF70-12	25	13,0	12,0	14,0	58	50	17	V600, V1300
2/0	KRF70-16	28	13,0	15,0	17,0	64	50	17	V600, V1300
4/0	KRF95-8	29	15,0	15,0	17,0	69	50	20	V600, V1300
4/0	KRF95-10	29	15,0	15,0	17,0	69	50	20	V600, V1300
4/0	KRF95-12	29	15,0	15,0	17,0	69	50	20	V600, V1300
4/0	KRF95-16	29	15,0	15,0	17,0	69	50	20	V600, V1300
250	KRF120-10	32	17,0	15,0	17,0	73	25	22	V1300, V250
250	KRF120-12	32	17,0	15,0	17,0	73	25	22	V1300, V250
250	KRF120-16	32	17,0	15,0	17,0	73	25	22	V1300, V250
300	KRF150-10	36	19,0	15,0	16,0	80	25	25	V1300, V250
300	KRF150-12	36	19,0	15,0	16,0	80	25	25	V1300, V250
300	KRF150-16	36	19,0	15,0	16,0	80	25	25	V1300, V250
300	KRF150-20	36	19,0	19,0	19,0	87	25	25	V1300, V250
350	KRF185-10	39	21	15,0	16,0	86	20	27	V1300, V250
350	KRF185-12	39	21	15,0	16,0	86	20	27	V1300, V250
350	KRF185-16	39	21	15,0	16,0	86	20	27	V1300, V250
350	KRF185-20	39	21	19,0	19	93	20	27	V1300, V250
500	KRF240A-10	42	22,5	19	20	96	10	30	V1300, V250
500	KRF240A-12	42	22,5	19	20	96	10	30	V1300, V250
500	KRF240A-16	42	22,5	19	20	96	10	30	V1300, V250
500	KRF240A-20	42	22,5	19	20	96	10	30	V1300, V250

** total palm length

Table continue on next page. →



For detailed information regarding recommended tool or system, see chapter 6.



Cu terminals and connectors 0.75 - 1000 mm²

AWG	Cat. no. mm ² - bolt hole M	mm W	d	N	N ₁	L	Pcs/ pack	Die no.	Rec. tool
600	KRF300A-10	46	24,5	15	19	93	10	32	V1300, V250
600	KRF300A-12	46	24,5	15	19	93	10	32	V1300, V250
600	KRF300A-16	46	24,5	20	20	99	10	32	V1300, V250
600	KRF300A-20	46	24,5	23	25	99	10	32	V1300, V250
600	KRF300A-24	46	24,5	23	25	107	10	32	V1300, V250
750	KRF400A-00	56	30	-	-	118	10	38	V1300, V250
750	KRF400A-12	56	30	15	25	111	10	38	V1300, V250
750	KRF400A-16	56	30	20	20	111	10	38	V1300, V250
750	KRF400A-20	56	30	23	25	118	10	38	V1300, V250
750	KRF400A-24	56	30	23	25	118	10	38	V1300, V250
For flexible Cu-conductors									
1000	KRF500-00	61	33	70**		160	5	42	V250
1000	KRF500-16	61	33	25	35	150	5	42	V250
1000	KRF500-20	61	33	25	35	150	5	42	V250
1000	KRF500-24	61	33	25	35	150	5	42	V250
	KRF630-00	75	39	80**		195	1	53	V250
	KRF630-20	75	39	35	45	195	1	53	V250
	KRF630-24	75	39	35	45	195	1	53	V250
	KRF800-00	75	42	80**		195	1	53	V250
	KRF800-24	75	42	35	45	195	1	53	V250
For stranded Cu-conductors									
	KRD500-00	58	31	70**		160	5	40	V250
	KRD500-16	58	31	25	35	150	5	40	V250
	KRD500-20	58	31	25	35	150	5	40	V250
	KRD500-24	58	31	25	35	150	5	40	V250
	KRD630-00	65	34	75**		165	1	45	V250
	KRD630-20	65	34	25	35	150	1	45	V250
	KRD630-24	65	34	25	35	150	1	45	V250
	KRD800-00	75	39	80**		195	1	53	V250
	KRD800-24	75	39	35	45	195	1	53	V250
	KRD1000-00	80	43	80**		195	1	56	V1470

** total palm length

For detailed information regarding recommended tool or system, see chapter 6.



Tube terminals 10 - 1000 mm², KRT

- Data: electrolytic copper, tin plated.
- Cable inspection hole, for stranded (class 2) Cu-conductors.
- UL-approved (KRT 10-500 mm²). DNV-approved (KRT 10-400 mm²).

Marking example KRT: 70 10 (Elpress logotype included)

70 = mm²

10 = palm hole for M10

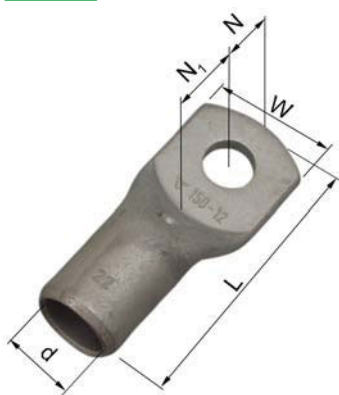

AWG	Cat. no.	mm W	d	N	N ₁	L	Pcs/ pack	Die no.	Rec. tool
8	KRT10-5	10	4,5	6	8	29	100	7	V600, V1300
8	KRT10-6	10	4,5	6	8	29	100	7	V600, V1300
8	KRT10-8	13	4,5	8	11	34	100	7	V600, V1300
8	KRT10-10	16	4,5	8	11	34	100	7	V600, V1300
8	KRT10-12	19	4,5	10	14	41	100	7	V600, V1300
6	KRT16-5	12	5,5	6	8	34	100	8,5	V600, V1300
6	KRT16-6	12	5,5	6	8	34	100	8,5	V600, V1300
6	KRT16-8	15	5,5	8	11	39	100	8,5	V600, V1300
6	KRT16-10	16	5,5	8	11	39	100	8,5	V600, V1300
6	KRT16-12	19	5,5	10	15	47	100	8,5	V600, V1300
4	KRT25-6	14	7	9	12	43	100	10	V600, V1300
4	KRT25-8	15	7	9	12	43	100	10	V600, V1300
4	KRT25-10	16	7	9	12	43	100	10	V600, V1300
4	KRT25-12	19	7	12	13	48	100	10	V600, V1300
2	KRT35-6	17	8,5	9,5	11,5	49	100	12	V600, V1300
2	KRT35-8	17	8,5	9,5	11,5	49	100	12	V600, V1300
2	KRT35-10	19	8,5	9,5	11,5	49	100	12	V600, V1300
2	KRT35-12	22	8,5	12	14	53	100	12	V600, V1300
1/0	KRT50-6	20	10	11	12	53	100	14	V600, V1300
1/0	KRT50-8	20	10	11	12	53	100	14	V600, V1300
1/0	KRT50-10	20	10	11	12	53	100	14	V600, V1300
1/0	KRT50-12	22	10	12	14	56	100	14	V600, V1300
2/0	KRT70-8	23	12	11	12	55	100	16	V600, V1300
2/0	KRT70-10	23	12	11	12	55	100	16	V600, V1300
2/0	KRT70-12	23	12	12	14	58	100	16	V600, V1300
4/0	KRT95-8	26	13,5	11	12	60	100	18	V600, V1300
4/0	KRT95-10	26	13,5	11	12	60	100	18	V600, V1300
4/0	KRT95-12	26	13,5	12	14	63	100	18	V600, V1300
4/0	KRT95-16	28	13,5	15	17	69	100	18	V600, V1300
250	KRT120-10	28	15	11	14	64	100	19	V1300, V250
250	KRT120-12	28	15	12	14	64	100	19	V1300, V250
250	KRT120-16	28	15	15	17	70	100	19	V1300, V250
300	KRT150-12	32	17	15	17	76	50	22	V1300, V250
300	KRT150-16	32	17	15	17	76	50	22	V1300, V250
300	KRT150-20	32	17	19	20	83	50	22	V1300, V250
350	KRT185-12	35	19	15	17	79	50	24	V1300, V250
350	KRT185-16	35	19	15	17	79	50	24	V1300, V250
350	KRT185-20	35	19	19	20	86	50	24	V1300, V250
500	KRT240-12	38	21	15	17	86	50	26	V1300, V250
500	KRT240-16	38	21	15	17	86	50	26	V1300, V250
500	KRT240-20	38	21	19	20	93	50	26	V1300, V250
600	KRT300-12	44	24	19	20	100	25	30	V1300, V250
600	KRT300-16	44	24	19	20	100	25	30	V1300, V250
600	KRT300-20	44	24	19	20	100	25	30	V1300, V250

** total palm length

Table continue on next page. →

For detailed information regarding recommended tool or system, see chapter 6.



Cu terminals and connectors 0.75 - 1000 mm²

AWG	Cat. no.	mm W	d	N	N ₁	L	Pcs/ pack	Die no.	Rec. tool
750	KRT400-16	48	26	21	31	114	25	32	V1300, V250
750	KRT400-20	48	26	21	31	114	25	32	V1300, V250
750	KRT400-24	48	26	21	31	114	25	32	V1300, V250
1000	KRT500-00	58	31	70**	-	160	-	40	V250
1000	KRT500-16	58	31	25	35	150	-	40	V250
1000	KRT500-20	58	31	25	35	150	-	40	V250
1000	KRT500-24	58	31	25	35	150	-	40	V250
	KRT630-00	65	34	70**	-	160	-	45	V250
	KRT630-20	65	34	25	35	150	-	45	V250
	KRT630-24	65	34	25	35	150	-	45	V250
	KRT800-00	75	39	80**	-	195	-	53	V250
	KRT800-24	75	39	35	45	195	-	53	V250
	KRT1000-00	80	43	80**	-	195	-	56	V1470

** total palm length

For detailed information regarding recommended tool or system, see chapter 6.



Tube terminals 16 - 1000 mm², KRD

■ Data: electrolytic copper, tin plated.

■ Cable inspection hole, for stranded (class 2) Cu-conductors.

Marking example KRD: 70 10 (Elpress logotype included)

70 = mm²

10 = palm hole for M10

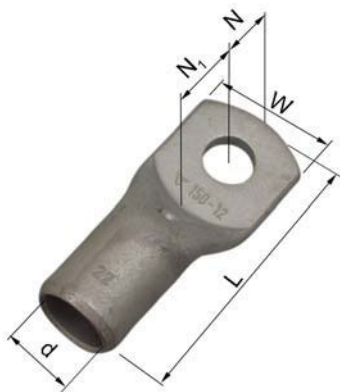

Cat. no.	mm W	d	N	N ₁	L	Pcs/ pack	Die no.	Rec. tool
KRD16-5	12	5,4	6	8	29	100	8	V600, V1300
KRD16-6	12	5,4	6	8	29	100	8	V600, V1300
KRD16-8	14	5,4	8	9	33	100	8	V600, V1300
KRD16-10	16	5,4	8	10	34	100	8	V600, V1300
KRD16-12	18	5,4	10	14	41	100	8	V600, V1300
KRD25-6	13	6,7	7	9	32	100	9	V600, V1300
KRD25-8	13	6,7	7	9	32	100	9	V600, V1300
KRD25-10	16	6,7	10	12	38	100	9	V600, V1300
KRD25-12	22	6,7	12	13	47	100	9	V600, V1300
KRD35-6	16	8	8	10	39	100	11	V600, V1300
KRD35-8	16	8	8	10	39	100	11	V600, V1300
KRD35-10	17	8	10	11	42	100	11	V600, V1300
KRD35-12	22	8	12	13	47	100	11	V600, V1300
KRD50-6	18	9,5	8,5	11,5	44	100	12	V600, V1300
KRD50-8	18	9,5	8,5	11,5	44	100	12	V600, V1300
KRD50-10	18	9,5	9,5	11,5	49	100	12	V600, V1300
KRD50-12	20	9,5	12	14	53	100	12	V600, V1300
KRD70-8	22	11,3	11	12	54	50	14	V600, V1300
KRD70-10	22	11,3	11	12	54	50	14	V600, V1300
KRD70-12	22	11,3	12	14	57	50	14	V600, V1300
KRD95-8	24	13	11	12	58	50	16	V600, V1300
KRD95-10	24	13	11	12	58	50	16	V600, V1300
KRD95-12	24	13	12	14	61	50	16	V600, V1300
KRD95-16	28	13	15	17	67	50	16	V600, V1300
KRD120-10	28	15	11	15	64	50	19	V1300, V250
KRD120-12	28	15	11	15	64	50	19	V1300, V250
KRD120-16	28	15	15	17	70	50	19	V1300, V250
KRD150-12	32	17	15	17	76	50	22	V1300, V250
KRD150-16	32	17	15	17	76	50	22	V1300, V250
KRD150-20	32	17	19	20	83	50	22	V1300, V250
KRD185-12	36	19	15	17	80	50	25	V1300, V250
KRD185-16	36	19	15	17	80	50	25	V1300, V250
KRD185-20	36	19	19	20	87	50	25	V1300, V250
KRD240-12	39	21	15	17	86	50	27	V1300, V250
KRD240-16	39	21	15	17	86	50	27	V1300, V250
KRD240-20	39	21	19	20	93	50	27	V1300, V250
KRD300-12	44	24	19	20	100	25	30	V1300, V250
KRD300-16	44	24	19	20	100	25	30	V1300, V250
KRD300-20	44	24	19	20	100	25	30	V1300, V250
KRD400-16	48	26	22	31	116	25	32	V1300, V250
KRD400-20	48	26	22	31	116	25	32	V1300, V250
KRD400-24	48	26	22	31	116	25	32	V1300, V250
KRD500-00	58	31	70**		160	5	40	V250
KRD500-16	58	31	25	35	150	5	40	V250
KRD500-20	58	31	25	35	150	5	40	V250
KRD500-24	58	31	25	35	150	5	40	V250

** total palm length

Table continue on next page. →

For detailed information regarding recommended tool or system, see chapter 6.



Cat. no.	mm W	d	N	N ₁	L	Pcs/pack	Die no.	Rec. tool
KRD630-00	65	34	75**		165	1	45	V250
KRD630-20	65	34	25	35	150	1	45	V250
KRD630-24	65	34	25	35	150	1	45	V250
KRD800-00	75	39	80**		195	1	53	V250
KRD800-24	75	39	35	45	195	1	53	V250
KRD1000-00	80	43	80**		195	1	56	V1470

** total palm length

Cu terminals 50 - 240 mm², KRFN, with narrow palm

- Data: electrolytic copper, tin plated.
- Cable inspection hole, for stranded (class 2) and flexible (class 5) Cu-conductors.
- Easy to mount through conduits, enables pre-assembly.

Marking example KRF: 70 10F (Elpress logotype included)

70 = mm² 10 = palm hole for M10 F = type KRF, for stranded and flexible conductors

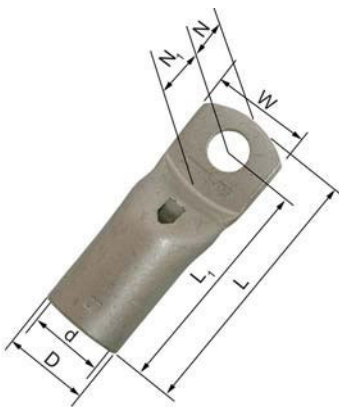

Cat. no. mm ² , Bolt	mm W	d	D	N	N ₁	L ₁	L	Pcs/Pack	Die no.	Rec. tool
KRFN50-6	18	11	14,5	11	11	40	51	100	14,5	V600, V1300
KRFN50-8	18	11	14,5	11	11,5	40	51	100	14,5	V600, V1300
KRFN50-10	18	11	14,5	11	11,5	40	51	100	14,5	V600, V1300
KRFN70-6	20	13,0	17,0	11	11,5	45	56	50	14,5	V600, V1300
KRFN70-8	20	13,0	17,0	11	11,5	45	56	50	17	V600, V1300
KRFN70-10	20	13,0	17,0	11	11,5	45	56	50	17	V600, V1300
KRFN95-8	24	15,0	20,0	11	12	50	61	50	20	V600, V1300
KRFN95-10	24	15,0	20,0	11	13	51	62	50	20	V600, V1300
KRFN95-12	24	15,0	20,0	12	14	52	64	50	20	V600, V1300
KRFN120-8	26	17,0	22,0	11	12	54	65	50	22	V1300, V250
KRFN120-10	26	17,0	22,0	11	13	55	66	50	22	V1300, V250
KRFN120-12	26	17,0	22,0	12	14	56	68	50	22	V1300, V250
KRFN150-10	30	19,0	25,0	11	13	62	73	50	25	V1300, V250
KRFN150-12	30	19,0	25,0	12	14	63	75	50	25	V1300, V250
KRFN185-10	32	21,0	27,0	11	14	69	80	25	27	V1300, V250
KRFN185-12	32	21,0	27,0	12	15	70	82	25	27	V1300, V250
KRFN185-16	32	21,0	27,0	15	16	71	86	25	27	V1300, V250
KRFN240A-10	38	22,5	29,0	11	16	73	84	50	30	V1300, V250
KRFN240A-12	38	22,5	29,0	12	15	72	84	50	30	V1300, V250
KRFN240A-16	38	22,5	29,0	15	18	75	90	50	30	V1300, V250



KRFN terminals suitable for narrow spaces.



Easy to mount through conduits.

For detailed information regarding recommended tool or system, see chapter 6.



Tube terminals with two stud holes 35 - 400 mm², KRF

- Data: electrolytic copper, tin plated.
- Cable inspection hole, for stranded (class 2) and flexible (class 5) Cu-conductors.
- UL-approved (KRF 35-400 mm²). DNV-approved (marked with *).

Marking example KRF: 70 10F (Elpress logotype included)

70 = mm² 10 = palm hole for M10 F = type KRF, for flexible and stranded conductors

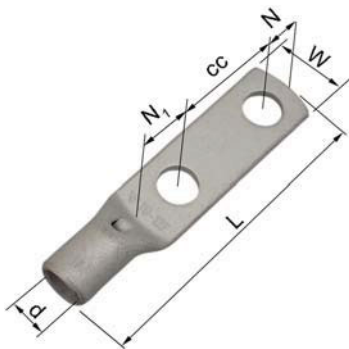

AWG	Cat. no. mm ² , bolt hole, cc-measure	mm W	d	N	N ₁	L	Pcs/ pack	Die no.	Rec. tool
2	KRF35-10X2-24-26	18,5	9	11	16	78	100	13	V600, V1300
1/0	KRF50-10X2-24-26	20,5	11	11	16	82	100	14,5	V600, V1300
2/0	KRF70-10x2-24-26	25	13,0	11	17	86	50	17	V600, V1300
2/0	KRF70-12X2-40*	25	13,0	12	18	103	25	17	V600, V1300
4/0	KRF95-10X2-24-26	29	15,0	11	19	93	25	20	V600, V1300
4/0	KRF95-12X2-40*	29	15,0	12	18	109	25	20	V600, V1300
250	KRF120-10X2-24-26	32	17,0	11	19	97	25	22	V1300, V250
250	KRF120-12X2-40*	32	17,0	12	19	113	25	22	V1300, V250
300	KRF150-10X2-24-26	36	19,0	11	19	104	25	25	V1300, V250
300	KRF150-12X2-40	36	19,0	12	19	120	20	25	V1300, V250
350	KRF185-10X2-24-26	39	21	13	19	111	20	27	V1300, V250
350	KRF185-12X2-40*	39	21	12	20	126	20	27	V1300, V250
500	KRF240A-10X2-24-26	42	22,5	11	22	115	10	30	V1300, V250
500	KRF240A-12X2-40*	42	22,5	12	21	130	10	30	V1300, V250
600	KRF300A-12X2-40*	46	24,5	12	22	133	5	32	V1300, V250
750	KRF400A-12X2-40	56	30	12	23	145	1	38	V1300, V250

* DNV-approved



For detailed information regarding recommended tool or system, see chapter 6.



Tube terminals 45°, 10 - 150 mm², KRF

- Data: electrolytic copper, tin plated.
- Cable inspection hole, for stranded (class 2) and flexible (class 5) Cu-conductors.
- UL-approved (KRF 35-150 mm²). DNV-approved (16-150 mm²).

Marking example KRF: 70 10F (Elpress logotype included)

70 = mm² 10 = palm hole for M10 F = type KRF, for stranded and flexible conductors

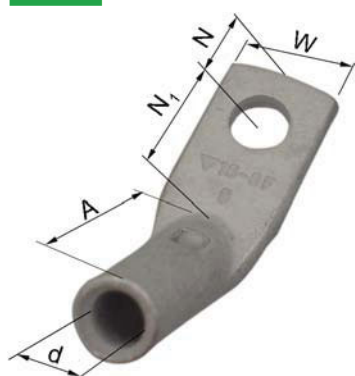

AWG	Cat. no. mm ² , Bolt, 45°	mm W	d	N	N ₁	A	Pcs/ pack	Die no.	Rec. tool
8	KR10-6-45GR	13,0	5,0	6,5	11,5	19	100	8	V600, V1300
8	KR10-8-45GR	13,5	5,0	8,5	12,0	19	100	8	V600, V1300
6	KRF16-6-45GR	13,0	6,0	6,5	11,5	23	100	9	V600, V1300
6	KRF16-8-45GR	13,5	6,0	8,5	12,0	23	100	9	V600, V1300
4	KRF25-6-45GR	17,0	8,0	6,5	11,5	24	100	11	V600, V1300
4	KRF25-8-45GR	17,0	8,0	8,5	12,0	24	100	11	V600, V1300
4	KRF25-10-45GR	17,0	8,0	11,5	13,5	24	100	11	V600, V1300
2	KRF35-6-45GR	18,0	9,0	6,5	11,5	30	100	13	V600, V1300
2	KRF35-8-45GR	18,0	9,0	8,5	12,0	30	100	13	V600, V1300
2	KRF35-10-45GR	18,0	9,0	11,5	13,5	30	100	13	V600, V1300
1/0	KRF50-8-45GR	21	11,0	8,5	17,5	31	100	14,5	V600, V1300
1/0	KRF50-10-45GR	21	11,0	11,5	18,5	31	100	14,5	V600, V1300
1/0	KRF50-12-45GR	21	11,0	12,5	19,5	31	100	14,5	V600, V1300
2/0	KRF70-8-45GR	25	13,0	8,5	17,5	35	50	17	V600, V1300
2/0	KRF70-10-45GR	25	13,0	11,5	18,5	35	50	17	V600, V1300
2/0	KRF70-12-45GR	25	13,0	12,5	19,5	35	50	17	V600, V1300
4/0	KRF95-10-45GR	29	15,0	11,5	18,5	40	50	20	V600, V1300
4/0	KRF95-12-45GR	29	15,0	12,5	19,5	40	50	20	V600, V1300
4/0	KRF95-16-45GR	29	15,0	15,5	20,5	40	50	20	V600, V1300
250	KRF120-10-45GR	32	17,0	11,5	18,5	43	25	22	V1300, V250
250	KRF120-12-45GR	32	17,0	12,5	19,5	43	25	22	V1300, V250
250	KRF120-16-45GR	32	17,0	15,5	20,4	43	25	22	V1300, V250
300	KRF150-10-45GR	36	19,0	11,5	18,5	49	25	25	V1300, V250
300	KRF150-12-45GR	36	19,0	12,5	19,5	49	25	25	V1300, V250
300	KRF150-16-45GR	36	19,0	15,5	20,5	49	25	25	V1300, V250

For detailed information regarding recommended tool or system, see chapter 6.



Tube terminals 45°, 10 - 120 mm², KRT

- Data: electrolytic copper, tin plated.
- Without cable inspection hole, for stranded (class 2) Cu-conductors.
- UL-approved. DNV-approved.

Marking example KRF: 70 10F (Elpress logotype included)

70 = mm² 10 = palm hole for M10 F = type KRF, for stranded and flexible conductors

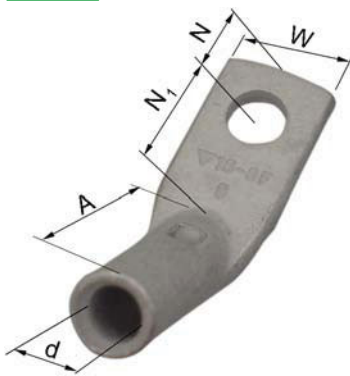

AWG	Cat. no.	mm W	d	N	N ₁	A	Pcs/pack	Die no.	Rec. tool
8	KRT10-6NS-45GR	13	4,5	6,5	11,5	20	100	7	V600, V1300
8	KRT10-8NS-45GR	13,5	4,5	8,5	12	20	100	7	V600, V1300
6	KRT16-6NS-45GR	13	5,4	6,5	11,5	23	100	8,5	V600, V1300
6	KRT16-8NS-45GR	13,5	5,4	8,5	12	23	100	8,5	V600, V1300
6	KRT16-10NS-45GR	16	5,4	11,5	13,5	23	100	8,5	V600, V1300
4	KRT25-6NS-45GR	14	7	6,5	11,5	26	100	10	V600, V1300
4	KRT25-8NS-45GR	14	7	8,5	12	26	100	10	V600, V1300
4	KRT25-10NS-45GR	16	7	11,5	13,5	26	100	10	V600, V1300
2	KRT35-6NS-45GR	17	8,5	6,5	11,5	30	100	12	V600, V1300
2	KRT35-8NS-45GR	17	8,5	8,5	12	30	100	12	V600, V1300
2	KRT35-10NS-45GR	19	8,5	11,5	13,5	30	100	12	V600, V1300
1/0	KRT50-8NS-45GR	20	10	8,5	17,5	32	100	14	V600, V1300
1/0	KRT50-10NS-45GR	20	10	11,5	18,5	32	100	14	V600, V1300
1/0	KRT50-12NS-45GR	22	10	12,5	19,5	32	100	14	V600, V1300
2/0	KRT70-8NS-45GR	23	12	8,5	17,5	38	50	16	V600, V1300
2/0	KRT70-10NS-45GR	23	12	11,5	18,5	38	50	16	V600, V1300
2/0	KRT70-12NS-45GR	23	12	12,5	19,5	38	50	16	V600, V1300
4/0	KRT95-8NS-45GR	28	13,5	8,5	17,5	38	50	18	V600, V1300
4/0	KRT95-10NS-45GR	28	13,5	11,5	18,5	38	50	18	V600, V1300
4/0	KRT95-12NS-45GR	28	13,5	12,5	19,5	38	50	18	V600, V1300
4/0	KRT95-16NS-45GR	28	13,5	15,5	20,5	38	50	18	V600, V1300
250	KRT120-10NS-45GR	29	15	11,5	18,5	41	25	19	V600, V1300
250	KRT120-12NS-45GR	29	15	12,5	19,5	41	25	19	V600, V1300
250	KRT120-16NS-45GR	29	15	15,5	20,5	41	25	19	V600, V1300



For detailed information regarding recommended tool or system, see chapter 6.



Tube terminals 90° degrees 10 - 150 mm², KRF

- Data: electrolytic copper, tin plated.
- Cable inspection hole, for stranded (class 2) and flexible (class 5) Cu-conductors.
- UL-approved (35-150 mm²). DNV-approved (16-150 mm²).

Marking example KRF: 70 10F (Elpress logotype included)

70 = mm² 10 = palm hole for M10 F = type KRF, for stranded and flexible conductors



AWG	Cat. no. mm ² , Bolt	mm W	d	N	N ₁	A	Pcs/ pack	Die no.	Rec. tool
8	KR10-6-90GR	13,0	5,0	6,5	11,5	15	100	8	V600, V1300
8	KR10-8-90GR	13,5	5,0	8,5	12,0	15	100	8	V600, V1300
6	KRF16-6-90GR	13,0	6,0	6,5	11,5	16,5	100	9	V600, V1300
6	KRF16-8-90GR	13,5	6,0	8,5	12,0	16,5	100	9	V600, V1300
4	KRF25-6-90GR	17,0	8,0	6,5	11,5	18,5	100	11	V600, V1300
4	KRF25-8-90GR	17,0	8,0	8,5	12,0	18,5	100	11	V600, V1300
4	KRF25-10-90GR	17,0	8,0	11,5	13,5	18,5	100	11	V600, V1300
2	KRF35-6-90GR	18,0	9,0	6,5	11,5	22,5	100	13	V600, V1300
2	KRF35-8-90GR	18,0	9,0	8,5	12,0	22,5	100	13	V600, V1300
2	KRF35-10-90GR	18,0	9,0	11,5	13,5	22,5	100	13	V600, V1300
1/0	KRF50-8-90GR	21	11,0	8,5	17,5	30,5	100	14,5	V600, V1300
1/0	KRF50-10-90GR	21	11,0	11,5	18,5	30,5	100	14,5	V600, V1300
1/0	KRF50-12-90GR	21	11,0	12,5	19,5	30,5	100	14,5	V600, V1300
2/0	KRF70-8-90GR	25	13,0	8,5	17,5	31,5	50	17	V600, V1300
2/0	KRF70-10-90GR	25	13,0	11,5	18,5	31,5	50	17	V600, V1300
2/0	KRF70-12-90GR	25	13,0	12,5	19,5	31,5	50	17	V600, V1300
4/0	KRF95-10-90GR	29	15,0	11,5	18,5	32,5	50	20	V600, V1300
4/0	KRF95-12-90GR	29	15,0	12,5	19,5	32,5	50	20	V600, V1300
4/0	KRF95-16-90GR	29	15,0	15,5	20,5	32,5	50	20	V600, V1300
250	KRF120-10-90GR	32	17,0	11,5	18,5	34,5	25	22	V1300, V250
250	KRF120-12-90GR	32	17,0	12,5	19,5	34,5	25	22	V1300, V250
250	KRF120-16-90GR	32	17,0	15,5	20,5	34,5	25	22	V1300, V250
300	KRF150-10-90GR	36	19,0	11,5	18,5	37,5	25	25	V1300, V250
300	KRF150-12-90GR	36	19,0	12,5	19,5	37,5	25	25	V1300, V250
300	KRF150-16-90GR	36	19,0	15,5	20,5	37,5	25	25	V1300, V250

For detailed information regarding recommended tool or system, see chapter 6.

**Tube terminals 90° degrees 10 - 120 mm², KRT**

- Data: electrolytic copper, tin plated.
- For stranded (class 2) Cu-conductors.
- KRT-types are without inspection hole (NS).
- UL-approved. DNV-approved.

Marking example KRF: 70 10F (Elpress logotype included)

70 = mm² 10 = palm hole for M10 F = type KRF, for stranded and flexible conductors

AWG	Cat. no.	mm W	d	N	N ₁	A	Pcs/Pack	Die no.	Rec. tool
8	KRT10-6NS-90GR	13	4,5	6,5	11,5	15,5	100	7	V600, V1300
8	KRT10-8NS-90GR	13,5	4,5	8,5	12	15,5	100	7	V600, V1300
6	KRT16-6NS-90GR	13	5,4	6,5	11,5	16,5	100	8,5	V600, V1300
6	KRT16-8NS-90GR	13,5	5,4	8,5	12	16,5	100	8,5	V600, V1300
6	KRT16-10NS-90GR	16	5,4	11,5	13,5	17	100	8,5	V600, V1300
4	KRT25-6NS-90GR	14	7	6,5	11,5	20	100	10	V600, V1300
4	KRT25-8NS-90GR	14	7	8,5	12	20	100	10	V600, V1300
4	KRT25-10NS-90GR	16	7	11,5	13,5	20	100	10	V600, V1300
2	KRT35-6NS-90GR	17	8,5	6,5	11,5	23,5	100	12	V600, V1300
2	KRT35-8NS-90GR	17	8,5	8,5	12	23,5	100	12	V600, V1300
2	KRT35-10NS-90GR	19	8,5	11,5	13,5	23,5	100	12	V600, V1300
1/0	KRT50-6NS-90GR	22	10	8,5	12	32,5	100	14	V600, V1300
1/0	KRT50-8NS-90GR	20	10	11,5	17,5	31,5	100	14	V600, V1300
1/0	KRT50-10NS-90GR	20	10	12,5	18,5	31,5	100	14	V600, V1300
2/0	KRT70-8NS-90GR	23	12	8,5	17,5	32,5	50	16	V600, V1300
2/0	KRT70-10NS-90GR	23	12	11,5	18,5	32,5	50	16	V600, V1300
2/0	KRT70-12NS-90GR	23	12	12,5	19,5	32,5	50	16	V600, V1300
4/0	KRT95-8NS-90GR	28	13,5	8,5	17,5	32,5	50	18	V600, V1300
4	KRT95-10NS-90GR	28	13,5	11,5	18,5	32,5	50	18	V600, V1300
4	KRT95-12NS-90GR	28	13,5	12,5	19,5	32,5	50	18	V600, V1300
4	KRT95-16NS-90GR	28	13,5	15,5	20,5	32,5	50	18	V600, V1300
250	KRT120-10NS-90GR	28	15	11,5	18,5	34,5	25	19	V600, V1300
250	KRT120-12NS-90GR	28	15	12,5	19,5	34,5	25	19	V600, V1300
250	KRT120-16NS-90GR	28	15	15,5	20,5	34,5	25	19	V600, V1300

For detailed information regarding recommended tool or system, see chapter 6.



Tube terminals 10 - 300 mm² DIN 46235

■ Data: electrolytic copper, tin plated.

■ Dimensions according to DIN 46235, number of crimps marked on the neck of the terminal.

Palm marking example: 70 10

70 = mm²

10 = palm hole for M10



Cat. no. mm ² , bolt	mm W	d	L	Pcs/ pack	DIN die no.	Rec tool
KR10-6DIN	9,0	4,4	27	100	6	V600, V1300
KR16-6DIN	13,0	5,5	36	100	8	V600, V1300
KR16-8DIN	13,0	5,5	37	100	8	V600, V1300
KR16-10DIN	16,5	5,5	38	100	8	V600, V1300
KR25-6DIN	14,0	7,0	39	100	10	V600, V1300
KR25-8DIN	17,0	7,0	39	100	10	V600, V1300
KR25-10DIN	17,0	7,0	40,5	100	10	V600, V1300
KR25-12DIN	18,0	7,0	40,5	100	10	V600, V1300
KR35-8DIN	18,0	8,2	42	100	12	V600, V1300
KR35-10DIN	19,0	8,2	42	100	12	V600, V1300
KR35-12DIN	21	8,2	43	100	12	V600, V1300
KR50-8DIN	20	10,0	52	100	14	V600, V1300
KR50-10DIN	22	10,0	52	100	14	V600, V1300
KR50-12DIN	24	10,0	52	100	14	V600, V1300
KR50-16DIN	28	10,0	55,5	100	14	V600, V1300
KR70-10DIN	24	11,3	56	50	16	V600, V1300
KR70-12DIN	24	11,3	56,5	50	16	V600, V1300
KR70-16DIN	29	11,3	57	50	16	V600, V1300
KR95-10DIN	28	13,5	65,5	50	18	V600, V1300
KR95-12DIN	28	13,5	65,5	50	18	V600, V1300
KR95-16DIN	32	13,5	65,5	50	18	V600, V1300
KR120-12DIN	31	15,5	70,5	50	20	V1300, V250
KR120-16DIN	31,5	15,5	72	25	20	V1300, V250
KR120-20DIN	36	15,5	72	25	20	V1300, V250
KR150-12DIN	34	17,0	78,5	25	22	V1300, V250
KR150-16DIN	34	17,0	78	25	22	V1300, V250
KR150-20DIN	38	17,0	78	25	22	V1300, V250
KR185-12DIN	37	19,0	82,5	25	25	V1300, V250
KR185-16DIN	37	19,0	82	25	25	V1300, V250
KR185-20DIN	40	19,0	83	25	25	V1300, V250
KR240-12DIN	42,5	21,5	92	10	28	V1300, V250
KR240-16DIN	42,5	22	92	10	28	V1300, V250
KR240-20DIN	45	22	92	25	28	V1300, V250
KR300-16DIN	48,5	24,5	100	10	32	V1300, V250
KR300-20DIN	48,5	24	100	10	32	V1300, V250

For detailed information regarding recommended tool or system, see chapter 6.



Sheet metal terminals 10 - 240 mm² DIN 46234

- Data: electrolytic copper, tin plated.
- Dimensions according to DIN 46234.

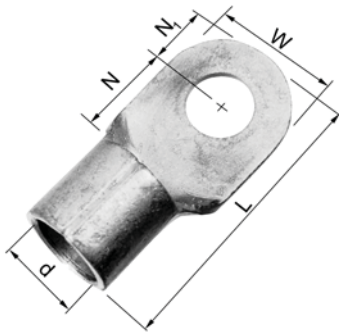

Cat. no. mm ² , bolt	mm W	d	N1	N	L	Pcs/ pack	Palm marking	Die no.	Rec. tool
B10-5R	10,0	4,5	5,0	8,0	21	100	10	7	GWB4010, V600
B10-6R	11,0	4,5	5,5	9,0	23	100	10	7	GWB4010, V600
B10-8R	14,0	4,5	7,0	12,0	27	100	10	7	GWB4010, V600
B10-10R	18,0	4,5	9,0	13,0	30	100	10	7	GWB4010, V600
B10-12R	22	4,5	11,0	15,0	34	100	10	7	GWB4010, V600
B16-5R	11,0	5,8	5,5	10,0	26	100	16	8	V600, V1300
B16-6R	11,0	5,8	5,5	10,0	26	100	16	8	V600, V1300
B16-8R	14,0	5,8	7,0	12,0	29	100	16	8	V600, V1300
B16-10R	18,0	5,8	9,0	14,0	33	100	16	8	V600, V1300
B16-12R	22	5,8	11,0	16,0	37	100	16	8	V600, V1300
B25-5R	12,0	7,5	6,0	14,0	31	100	25	10	V600, V1300
B25-6R	12,0	7,5	6,0	14,0	31	100	25	10	V600, V1300
B25-8R	16,0	7,5	8,0	14,0	33	100	25	10	V600, V1300
B25-10R	18,0	7,5	9,0	15,0	35	100	25	10	V600, V1300
B25-12R	22	7,5	11,0	20	42	100	25	10	V600, V1300
B25-16R	28	7,5	14,0	24	49	100	25	10	V600, V1300
B35-6R	15,0	9,0	7,5	14,0	34	100	35	12	V600, V1300
B35-8R	16,0	9,0	8,0	14,0	34	100	35	12	V600, V1300
B35-10R	18,0	9,0	9,0	15,0	36	100	35	12	V600, V1300
B35-12R	22	9,0	11,0	19,0	42	100	35	12	V600, V1300
B35-16R	28	9,0	14,0	24	50	100	35	12	V600, V1300
B50-6R	18,0	11,0	9,0	18,0	43	100	50	14,5	V600, V1300
B50-8R	18,0	11,0	9,0	18,0	43	100	50	14,5	V600, V1300
B50-10R	18,0	11,0	9,0	18,0	43	100	50	14,5	V600, V1300
B50-12R	22	11,0	11,0	20	47	100	50	14,5	V600, V1300
B50-16R	28	11,0	14,0	24	54	100	50	14,5	V600, V1300
B70-8R	22	13,0	11,0	20	49	100	70	17	V600, V1300
B70-10R	22	13,0	11,0	20	49	100	70	17	V600, V1300
B70-12R	22	13,0	11,0	20	49	100	70	17	V600, V1300
B70-16R	28	13,0	14,0	24	56	100	70	17	V600, V1300
B95-10R	24	15,0	12,0	22	54	100	95	20	V600, V1300
B95-12R	24	15,0	12,0	22	54	100	95	20	V600, V1300
B95-16R	28	15,0	14,0	24	58	100	95	20	V600, V1300
B120-10R	24	16,5	12,0	22	56	50	120	Contact elpress	V600, V1300
B120-12R	24	16,5	12,0	22	56	50	120	Contact elpress	V600, V1300
B120-16R	28	16,5	14,0	26	62	50	120	Contact elpress	V600, V1300
B150-12R	30	19,0	15,0	26	65	50	150	Contact elpress	V600, V1300
B150-16R	30	19,0	15,0	26	65	50	150	Contact elpress	V600, V1300
B185-12R	36	21	18,0	22	68	50	185	Contact elpress	V1300, V250
B185-16R	36	21	18,0	22	68	50	185	Contact elpress	V1300, V250
B240-12R	38	24	19,0	24	75	50	240	Contact elpress	V1300, V250
B240-16R	38	24	19,0	24	75	50	240	Contact elpress	V1300, V250

For detailed information regarding recommended tool or system, see chapter 6.



Through connectors 0,75 - 800 mm², KS/KSF

- Data: electrolytic copper, tin plated.
- Cable inspection hole and cable stop, for stranded (class 2) and flexible (class 5) Cu-conductors.
- UL-approved (1-500 mm²). DNV-approved (16-400 mm²).

Marking example: 20 95F 111 (earth-sign) Elpress logotype included

20 = die no. 95 = mm² F = type KSF, stranded and flexible conductors

111 = screen, mm²



AWG	Cat. no. mm ²	Screen cross section	mm d	D	L	Pcs/pack	Die no.	Rec. tool
(22)-18	KS0,75		1,3	2,8	14,0	100		DKB0760
(18)-16	KS1,5		1,8	3,3	14,0	100		DKB0760
(16)-14	KS2,5		2,3	4,2	16,0	100		DKB0760
12	KS4		3,0	5,0	19,0	100		GWB4099, ES2258
10	KS6		4,0	6,0	19,0	100		GWB4099, ES2258
8	KS10		5,0	8,0	30	100	8	GWB4099, ES2258
6	KSF16	15	6,0	9,0	35	100	9	V600, V1300
4	KSF25	21-29	8,0	11,0	35	100	11	V600, V1300
2	KSF35	41	9,0	13,0	35	100	13	V600, V1300
1/0	KSF50	57	11,0	14,5	45	50	14,5	V600, V1300
2/0	KSF70	72-88	13,0	17,0	45	50	17	V600, V1300
4/0	KSF95	111	15,0	20	45	50	20	V600, V1300
250	KSF120		17,0	22	55	50	22	V1300, V250
300	KSF150		19,0	25	65	25	25	V1300, V250
350	KSF185		21	27	70	25	27	V1300, V250
500	KSF240A		22,5	29	70	25	30	V1300, V250
600	KSF300A		24	31,5	75	10	32	V1300, V250
750	KSF400A		30	38	100	10	38	V1300, V250
For flexible Cu-conductors								
1000	KSF500		33	42	135	5	42	V250
	KSF630		39	53	175	3	53	V250
	KSF800		42	53	175	2	53	V250

For detailed information regarding recommended tool or system, see chapter 6.



Through connectors 10 - 800 mm², KST

- Data: electrolytic copper, tin plated.
- Cable inspection hole and cable stop, for stranded (class 2) Cu-conductors.
- UL-approved (10-500 mm²). DNV-approved (10-400 mm²).

Marking example: 18 95 Elpress logotype included

18 = die no. 95 = mm²



AWG	Cat. no.	mm d	D	L	Pcs/Pack	Die no.	Rec. tool
8	KST10	4,5	7	30	100	7	GWB4099
6	KST16	5,5	8,5	35	100	8,5	V600, V1300
4	KST25	7	10	40	100	10	V600, V1300
2	KST35	8,5	12	45	100	12	V600, V1300
1/0	KST50	10	14	50	50	14	V600, V1300
2/0	KST70	12	16	55	50	16	V600, V1300
4/0	KST95	13,5	18	60	50	18	V600, V1300
250	KST120	15	19	60	50	19	V1300, V250
300	KST150	17	22	65	50	22	V1300, V250
350	KST185	19	24	75	50	24	V1300, V250
500	KST240	21	26	85	50	26	V1300, V250
600	KST300	24	30	90	50	30	V1300, V250
750	KST400	26	32	90	50	32	V1300, V250
1000	KST500	31	40	135	5	40	V250
	KST630	34	45	135	5	45	V250
	KST800	39	53	175	1	53	V250

4

Through connectors 16 - 800 mm², KSD

- Data: electrolytic copper, tin plated.
- Cable inspection hole and cable stop, for stranded (class 2) Cu-conductors.

Marking example: 16 95 Elpress logotype included

16 = die no. 95 = mm²



Cat. no.	mm d	D	L	Pcs/Pack	Die no.	Rec. tool
KSD16	5,4	8	35	100	8	V600, V1300
KSD25	6,7	9	30	100	9	V600, V1300
KSD35	8	11	35	100	11	V600, V1300
KSD50	9,5	12	40	50	12	V600, V1300
KSD70	11,3	14	45	50	14	V600, V1300
KSD95	13	16	55	50	16	V600, V1300
KSD120	15	19	60	50	19	V1300, V250
KSD150	17	22	65	50	22	V1300, V250
KSD185	19	25	70	50	25	V1300, V250
KSD240	21	27	70	50	27	V1300, V250
KSD300	24	30	90	50	30	V1300, V250
KSD400	26	32	90	25	32	V1300, V250
KSD500	31	40	135	5	40	V250
KSD630	34	45	135	5	45	V250
KSD800	39	53	175	1	53	V250

For detailed information regarding recommended tool or system, see chapter 6.



Through connectors with partition 10 - 400 mm²

- Data: electrolytic copper, tin plated.
- With partition to prevent oil-leakage, for stranded (class 2) and flexible (class 5) Cu-conductors.

Marking example: 20 95F 111 (earth-sign) Elpress logotype included

20 = die no. 95 = mm² F = type KSF, stranded and flexible conductors

111 = screen, mm²



Cat.no. mm ²	Screen cond. area	mm d	D	L	Pcs/ pack	Die no.	Rec. tool
KS10M		5,0	8,0	36	100	8	GWB4099,V600
KSF16M	15	6,0	9,0	37	100	9	V600, V1300
KSF25M	21-29	8,0	11,0	38	100	11	V600, V1300
KSF35M	41	9,0	13,0	41	100	13	V600, V1300
KSF50M	57	11,0	14,5	48	50	14,5	V600, V1300
KSF70M	72-88	13,0	17,0	49	50	17	V600, V1300
KSF95M	111	15,0	20	56	50	20	V600, V1300
KSF120M		17,0	22	63	50	22	V1300, V250
KSF150M		19,0	25	64	25	25	V1300, V250
KSF185M		21	27	74	25	27	V1300, V250
KSF240AM		22,5	29	76	1	30	V1300, V250
KSF300AM		24,5	31,5	88	1	32	V1300, V250
KSF400AM		30,0	36	105	1	38	V1300, V250

Parallel connectors for total cross section areas 0.5 - 7.5 mm²

- Data: electrolytic copper, tin plated.
- For flexible (class 5) and stranded (class 2) Cu-conductors.



mm ² Total	Cat. no.	mm d	D	L	Pcs/ pack	Marking	Rec. tool
0,5-1,5	KS2x1P	1,6	3,2	7,0	100	-	DKB0325
1,5-3,5	KS2x2,5P	2,3	3,9	7,0	100	-	DKB0325
4-7,5	KS2x6P	3,6	5,6	7,0	100	-	DKB0760

Connectors for solid Cu conductors 6 - 16 mm²

- Data: electrolytic copper.
- For solid conductors (to IEC 60228 class 1).



mm ²	Cat. no.	Corresponding KS-connector	mm d	D	L	Pcs/ pack	Marking*	Rec. tool
6	CUT6	KS4	3,0	5,0	27	100	CUT6	ES2258
10	CUT10	KS6	4,0	6,0	27	100	CUT10	ES2258
16	CUT16	KS10	5,0	8,0	35	100	CUT16	EL2258

* Elpress logotype included in marking.

For detailed information regarding recommended tool or system, see chapter 6.



Pin terminals 10 - 95 mm² DIN 46230

- Data: electrolytic copper, tin plated.
- Dimensions according to DIN 46230.



mm ²	Cat. no.	mm W	L ₁	L	Inner Ø d	Pcs/pack	Die no.	Rec. tool
10	B10SR	4,3	12,0	22	4,5	100	7	V600, V1300
16	B16SR	5,5	13,0	26	5,8	100	8	V600, V1300
25	B25SR	6,8	15,0	34	7,0	100	10	V600, V1300
35	B35SR	8,0	20	41	8,7	100	12	V600, V1300
50	B50SR	9,5	20	45	9,8	50	14,5	V600, V1300
70	B70SR	11,0	23	55	11,5	50	17	V600, V1300
95	B95SR	12,3	23	55	13,8	50	20	V600, V1300

Tube terminals for Ericsson Cables Excel and Fxcel type 10 - 16 mm²

- Data: electrolytic copper, tin plated.
- For PEX-insulated cables 10 mm² Cu solid (Ericsson Excel type) and 16 mm² Cu stranded (Ericsson Fxcel type), to be applied non-tensioned.

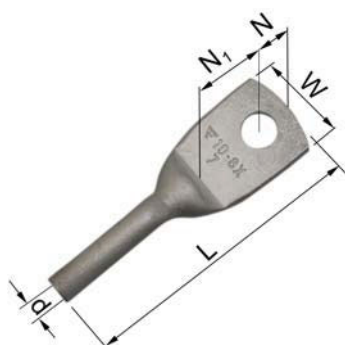

Cat. no. mm ² , bolt	mm W	d	N	N ₁	L	Pcs/pack	Crimp die id-no.	Rec. tool
KRX10-8	22	4,5	8,5	17,5	68	3	7	V600, V1300
KRX10-10	22	4,5	11,5	18,5	72	3	7	V600, V1300
KRX10-12	22	4,5	12,5	19,5	74	3	7	V600, V1300
KRX16-8	16	5,5	8,5	17,5	61	3	8,5	V600, V1300
KRX16-10	16	5,5	11,5	18,5	65	3	8,5	V600, V1300
KRX16-12	19	5,5	12,5	19,5	67	3	8,5	V600, V1300

Two crimps are made when using the V600-, V611-, PVL611- or T2600-systems, die TB7-20.

Connectors for Ericsson Cables Excel and Fxcel type 10 - 16 mm²

- Data: electrolytic copper, tin plated.
- For PEX-insulated cables 10 mm² Cu solid (Ericsson Excel type) and 16 mm² Cu stranded (Ericsson Fxcel type), to be applied non-tensioned.



Cat. no. mm ²	mm d	D	L	Pcs/pack	Marking*	Rec. tool
KSX10	4,5	7,0	65	3	10x7	V600, V1300
KSX16	5,5	8,5	65	3	16x8,5	V600, V1300

* Elpress logotype included.

Two plus two crimps are made when using the V600-, V611-, PVL611-, or T2600-Systems, die TB7-20.

For detailed information regarding recommended tool or system, see chapter 6.



Branch connectors (C-sleeves) 6 - 300 mm²

- Data: electrolytic copper.
- For connecting and branching of earth conductors, in some cases two adjacent compressions are necessary.
- C89, patented, tin plated.

Elpress logotype is included in the marking. On the "reverse side" the C-sleeve is marked with the applicable wire area ranges.

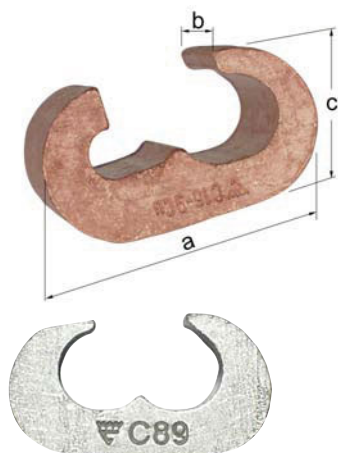

The patented C-sleeve C89 is tin plated.

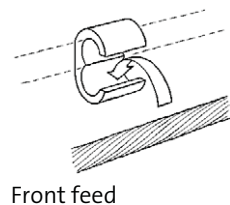
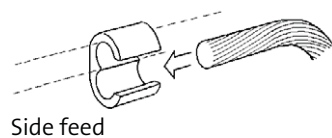

Cat. no.	Wire section area ranges		mm a	b	c	Pcs/Pack	Die id-no.
	Side feed	Front feed					
C4	10-6/10-6	10/6	13,0	12,0	8,0	100	4
C5	16-10/16-10	10/16-10	16	15	10	100	5
C6	25/16/25-16 25/10	16/25-16	22	16	12	100	6
C89	25-50/25-50 16-50/35-50	25-50/25-35 16-50/35	30	18	16/ 15,4	50	8-9
C11-8	70-50/35-25	50/35-25	31	23	19	50	11
C11-9	70-50/50-35	50/50-35	31	23	19	50	11
C11	70-50/70-50	50/70-50	31	23	19	50	11
C13-8	95-70/35-25	70/35-25	35	25	22	50	13
C13-9	95-70/50-35	70/50-35	35	25	22	50	13
C13-11	95-70/70-50	70/70-50	35	25	22	50	13
C13	96-70/95-70	70/95-70	35	25	22	50	13
C15-8	120-95/35-25	95/35-25	41	30	26	25	15
C15-9	120-95/50-35	95/50-35	41	30	26	25	15
C15-11	120-95/70-50	95/70-50	41	30	26	25	15
C15-13	120-95/95-70	95/95-70	41	30	26	25	15
C15	120-95/120-95	95/95	41	30	26	25	15
C16-9	150-120/50-35	150-120/50-35	53	35	30	10	16
C16-13	150-120/95-70	150-120/95-70	53	35	30	10	16
C16	150-120/150-120	150-120/150-120	53	35	30	10	16
C18-8	185-150/35	185-150/35	55	40	34	10	18
C18-9	185-150/50	185-150/50	55	40	34	10	18
C18-11	185-150/70	185-150/70	55	40	34	10	18
C18-13	185-150/95	185-150/95	55	40	34	10	18
C18-15	185-150/120	185-150/120	55	40	34	10	18
C18-16	185-150/150	185-150/150	55	40	34	10	18
C18	185/185	185/185	60	40	34	10	18
C21-8	240/35	240/35	55	40	34	10	18
C21-9	240/50	240/50	55	40	34	10	18
C21-11	240/70	240/70	55	40	34	10	18
C21-13	240/95	240/95	55	40	34	10	18
C21-15	240/120	240/120	55	40	34	10	18
C21-16	240/150	240/150	55	41	34	10	18
C21-18	240/185	240/185	70	40	40	10	21
C21	240/240	240/240	70	40	40	10	21
C23-16	300/150-120	300/150-120	70	40	40	10	21
C23	300/300	300/300	70	40	40	10	21

For detailed information regarding recommended tool or system, see chapter 6.



Application table for C-sleeves (side feed only)

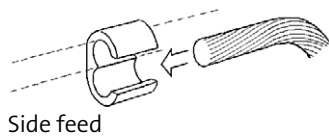

Side feed

Through conductor, mm ²	Branch conductor, mm ²					
	6	10	16	25	35	50
6	C4	C4				
10	C4	C4/C5	C5			
16		C5	C6	C6		
25		C6	C6	C6/C89	C89	
35			C89	C89	C89	C89
50			C89	C89	C89	C89
50				C11-8	C11-8/C11-9	C11-9/C11
70				C11-8	C11-8/C11-9	C11-9/C11
70				C13-8	C13-8	C13-11
95						C13-11
95				C15-8	C15-8/C15-9	C15-9/C15-11
120				C15-8	C15-8/C15-9	C15-9/C15-11
120						C16-9
150					C16-9	C16-9
150						C18-9
185					C18-8	C18-9
240					C21-8	C21-9
300						

Through conductor mm ²	Branch conductor, mm ²						
	70	95	120	150	185	240	300
6							
10							
16							
25							
35							
35							
50							
50	C11						
70	C11						
70	C13-11/C13	C13					
95	C13-11/C13	C13					
95	C15-11/C15-13	C15-3/C15	C15				
120	C15-11/C15-13	C15-13/C15	C15				
120	C16-13	C16-13	C16	C16			
150	C16-13	C16-13	C16	C16			
150	C18-11	C18-13	C18-15	C18-16			
185	C18-11	C18-13	C18-15	C18-16	C18		
240	C21-11	C21-13	C21-15	C21-16	C21-18	C21	
300				C23-16			C23

Note

- Open choice is marked with slash "/"
- When choosing between e.g. C11-9 and C11, use primarily C11
- The smaller sleeve is preferred, e.g. C8 in stead of C9, etc.

For detailed information regarding recommended tool or system, see chapter 6.



Notes

For detailed information regarding recommended tool or system, see chapter 6.



General information	2
Al terminals 16 - 1200 mm²	3
Al through connectors with partition 16 - 1200 mm²	4
Al through connectors with partition and for different areas 16 - 400 mm²	5
Al through connectors without partition 300 - 400 mm²	5
AlCu bimetallic terminals 16 - 1200 mm²	6
AlCu bimetallic terminals 300 - 400 mm²	7
AlCu pin terminals bimetallic 16 - 300 mm²	7
Transition connectors for Al conductors 16 - 95 mm² to Cu solid conductors 10 mm²	7
AlCu bimetallic through connectors 16 - 400 mm²	8
AlCu bimetallic through connectors 300 - 400 mm²	9



General information about Al and AlCu terminals

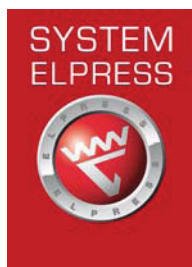

System Elpress consists of connectors and tools tested together for optimum connection result. The System concept makes you as a customer able to feel secure when using our system and to be sure a safe connection is made when Elpress products are used correctly.

Al terminals

Elpress terminals and connectors are made from pure aluminium 99.7%. We manufacture Al terminals type AK and AS. The standard range size is 16 to 1200 mm² but a variety of customer specified types also exists.



Al terminals type AK are mainly used for connection to Al bus bars, apparatus terminals or such.



Al connectors type AS are used to connect two Al conductors, also of different sizes.



Crimping of Elpress Al through connector with crimp head V250.

Al or AlCu types

Elpress AlCu terminals and connectors for Al cable are made from solid materials with friction welding. This method joins aluminum and copper material, when the aluminum part is rotated against the cop-

per part under pressure and is the method providing the best connection between Al and Cu.



Bimetallic terminals type AKK are mainly used for connection to Cu bus-bars, apparatus terminals or such.



Bimetallic connectors type AKS are used to connect an Al and a Cu conductor also of different sizes.



Bimetallic pin connectors type AKP are used to connect Al conductors to mechanical clamp type connections for round Cu pins.

Number of crimps

The Elpress Crimp System fits compacted/un-compacted stranded as well as solid Al conductors in accordance with IEC 60228. Note that in case of solid conductors one area step down is used as marked on the barrel. In case of sector-shaped conductors, pre-rounding is required and performed with tools within the Crimp System. This makes it possible to crimp the terminal in such a position that twisting is minimised when connecting to the bus bar or apparatus. Two indents are always made in the order shown in the picture above.



Customized products

Customized products are an important part of our offering. It is a special challenge to solve problems for customers in an efficient way, whereby we also gain knowledge about the requirements of different markets.

Marking of Al and AlCu terminals

Elpress System for marking of Al and AlCu terminals and connectors shows the stranded and solid metric conductor size and reference to the id-numbers of the

appropriate Elpress pre-rounding and crimp tools. Do not use other crimp tools! The T2-mark is a reference to an earlier Finnish standard. On bimetallic connectors there is also a tool id-reference to the hexagonal die to be used for the Cu-crimp.

TERMINALS:
Markings on Al and AlCu terminals
Barrel marking, example: ALU185-R18-P32 (Elpress logotype) T2 SOLID 240
ALU185 = Al conductor, mm ²
R18 = id-no. for punch and matrix for pre-rounding
P32 = id-no. for punch and matrix for crimping
T2 = Finnish temperature class
SOLID 240 = suitable size on solid conductor
Palm marking: (Elpress logotype) 16 = M-screw size

THROUGH CONNECTORS:
Markings on Al and AlCu connectors
Copper side of AlCu type Example: Cu240 - 30 (Elpress logotype)
Cu240 = Cu conductor, mm ²
30 = id-no. for hexagonal crimp die
Al connector or Al side of AlCu connector Example: ALU300-R21-P36 (Elpress logotype) T2
ALU300 = Al conductor, mm ²
R21 = id-no. of punch and matrix for pre-rounding
P36 = id-no. of punch and matrix for crimping
T2 = Finnish temperature class

Palm holes to ISO 273

Screw dimension	Palm hole tolerance H13 (Ø mm)
M 3	3,2
M 4	4,3
M 5	5,3
M 6	6,4
M 8	8,4
M 10	10,5
M 12	13
M 16	17
M 20	21
M 24	25



Al terminals 16 - 1200 mm²

- used to connect Al conductors to Al bus bars
- two adjacent crimps are necessary - crimp sequence see picture



Crimp sequence.

Cat. no. stranded, mm ²	Solid	mm W	d	N	N ₁	L	Pcs/ pack	Note	Rec. tool
AK16-6	25(16)	16,0	5,9	8,5	9,0	57	48		V1300
AK16-8	25 (16)	16,0	5,9	8,5	9,0	57	48		V1300
AK25-6	35	16,0	6,8	8,5	9,0	57	48		V1300
AK25-8	35	16,0	6,8	8,5	9,0	57	48		V1300
AK35-6	50	22	8,5	11,0	14,0	85	24		V1300
AK35-8	50	22	8,5	11,0	14,0	85	24		V1300
AK50-8	70	22	9,6	11,0	14,0	85	24		V1300
AK50-10	70	22	9,6	11,0	14,0	85	24		V1300
AK50-12	70	27	9,6	14,0	15,0	90	24		V1300
AK70-8	95	22	11,3	11,0	14,0	85	24		V1300
AK70-10	95	22	11,3	11,0	14,0	85	24		V1300
AK70-12	95	27	11,3	14,0	15,0	90	24		V1300
AK95-8	120	27	12,5	14,0	15,0	104	24		V1300
AK95-10	120	27	12,5	14,0	15,0	104	24		V1300
AK95-12	120	27	12,5	14,0	15,0	104	24		V1300
AK120-10	150	27	14,0	14,0	15,0	104	24		V1300
AK120-12	150	27	14,0	14,0	15,0	104	24		V1300
AK150-10	185	27	15,8	14,0	15,0	104	24		V1300
AK150-12	185	27	15,8	14,0	15,0	104	24		V1300
AK150-16	185	35	15,8	21	23	119	12		V1300
AK185-10	240	35	17,6	16,0	19,0	112	12		V1300
AK185-12	240	35	17,6	16,0	19,0	112	12		V1300
AK185-16	240	35	17,6	16,0	19,0	112	12		V1300
AK240-12		35	19,8	16,0	19,0	112	12		V1300, V250
AK240-16		35	19,8	16,0	19,0	112	12		V1300, V250
AK300-12SOLID		41	20	18,0	25	155	6	3	V250
AK300-16SOLID		41	20	18,0	25	155	6	3	V250
AK300-12		41	22	18,0	25	155	6		V250
AK300-16		41	22	18,0	25	155	6		V250
AK300-20		41	22	20	23	155	6		V250
AK400-12		41	25	18,0	25	155	6		V250
AK400-16		41	25	18,0	25	155	6		V250
AK400-20		41	25	20	23	155	6		V250
AK500A-16		55	28	26	29	225	1	4	V250
AK500A-20		55	28	26	29	225	3	4	V250
AK500A-1		38	28	80*		232	3	2,4	V250
AK500A-2		70	28	80*		250	3	2,4	V250
AK500B-16		44	28	22	22	174	3	5	V250
AK500B-20		44	28	22	22	174	3	5	V250
AK500B-1		44	28	80*		210	3	2,5	V250
AK500B-2		70	28	80*		210	3	2,5	V250
AK630A-1		55	32	80*		250	3	1,2	V250
AK630A-2		70	32	80*		250	3	1,2	V250
AK800-1		60	36	80*		267	1	1,2	V1470
AK800-2		75	36	80		275	1	1,2	V1470
AK1000-1		60	40	80*		267	1	1,2	V1470
AK1000-2		75	40	80*		375	1	1,2	V1470
AK1200		75	44	80*		291	1	1,2	V1470

Note

- 1 Stranded, compacted conductor
- 2 Unholed palm
- 3 For solid conductors only
- 4 Outer barrel diam. 52 mm.
- 5 Outer barrel diam. 44 mm.

* corresponds to the full palm length.

For detailed information regarding recommended tool or system, see chapter 6.



Al through connectors with partition 16 - 1200 mm²

- used mainly for connecting two Al conductors of the same size to each other
- two crimps on each side are necessary, crimp sequence see picture
- partition in the middle to prevent fluid flow

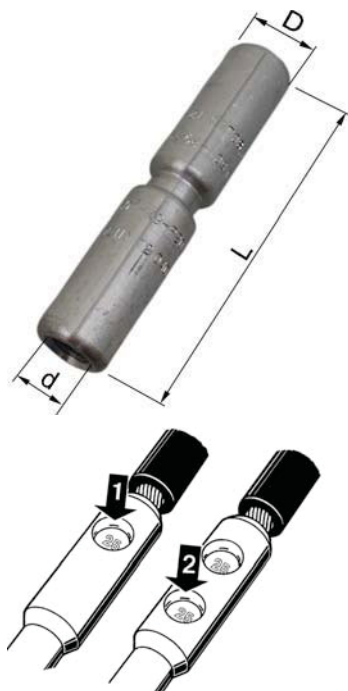

Crimp sequence.

Cat. no. stranded, mm ²	Solid mm ²	mm d	D	L	Pcs/ pack	Rec. tool	Note
AS16	25 (+16)	5,9	13,0	67	48	V1300	
AS25	35	6,8	13,0	67	48	V1300	
AS35	50	8,5	20	100	24	V1300	
AS50	70	9,6	20	100	24	V1300	
AS70	95	11,3	20	100	24	V1300	
AS95	120	12,5	25	130	12	V1300	
AS120	150	14,0	25	130	12	V1300	
AS150	185	15,8	25	130	12	V1300	
AS185	240	17,6	32	131	9	V1300	
AS240		19,8	32	131	9	V1300, V250	
AS300SOLID	300	20	36	179	6	V250	3
AS300		22	36	179	3	V250	
AS400		25	40	179	3	V250	
AS500A		28	52	250	3	V250	4
AS500B		28	44	184	3	V250	5
AS630A-1		32	52	250		V250	1
AS630-1		32	60	288		V250	1
AS800-1		36	60	288		V1470	1
AS1000-1		40	60	288		V1470	1
AS1200		44	70	320		V1470	1

If other combinations are needed, contact Elpress.

Note

- | | |
|---------------------------------|-----------------------------|
| 1 Stranded, compacted conductor | 4 Outer barrel diam. 52 mm. |
| 2 Unholed palm | 5 Outer barrel diam. 44 mm. |
| 3 For solid conductors only | |

Other designs of Al and AlCu terminals and connectors

In cases where other hole patterns, palm sizes, assembly angles, etc. are needed, a broad variety of customer specified items may be produced.

Some examples are indicated here: AKK500A/2-16-12x4-35 resp. AK185-14x2-40.



For detailed information regarding recommended tool or system, see chapter 6.



Al through connectors with partition and for different areas 16 - 400 mm²

- used mainly for connecting two Al conductors of different sizes to each other
- two crimps on each side are necessary, crimp sequence see picture
- partition in the middle to prevent fluid flow



Cat. no. stranded, mm ²	Solid mm ²	mm L	d ₁	D ₁	d	D	Pcs/pack	Rec. tool
AS25-16	35-25	67	5,9	13,0	6,8	13,0	48	V1300
AS35-25	50-35	85	6,8	13,0	8,5	20	24	V1300
AS50-25	70-35	85	6,8	13,0	9,6	20	24	V1300
AS50-35	70-50	100	8,5	20	9,6	20	24	V1300
AS70-50	95-70	100	9,6	20	11,3	20	24	V1300
AS95-25	120-35	101	6,8	13,0	12,5	25	24	V1300
AS95-35	120-50	116	8,5	20	12,5	25	24	V1300
AS95-50	120-70	116	9,6	20	12,5	25	24	V1300
AS95-70	120-95	116	11,3	20	12,5	25	24	V1300
AS120-95	150-120	130	12,5	25	14	25	12	V1300
AS150-50	185-70	116	9,6	20	15,8	25	12	V1300
AS150-70	185-95	116	11,3	20	15,8	25	24	V1300
AS150-95	185-120	130	12,5	25	15,8	25	12	V1300
AS150-120	185-150	130	14,0	25	15,8	25	12	V1300
AS185-95	240-120	132	12,5	25	17,6	32	12	V1300
AS185-150	240-185	132	15,8	25	17,6	32	12	V1300
AS240-95	-120	132	12,5	25	19,8	32	12	V1300, V250
AS240-120	-150	132	14,0	25	19,8	32	12	V1300, V250
AS240-150	-185	132	15,8	25	19,8	32	12	V1300, V250
AS240-185	-240	131	17,6	32	19,8	32	12	V1300, V250
AS300-240		156	19,8	32	22	36	6	V250
AS400-300		179	22	36	25	40	3	V250

Other measures, see corresponding connector on previous pages.
If other combinations are needed, contact Elpress.

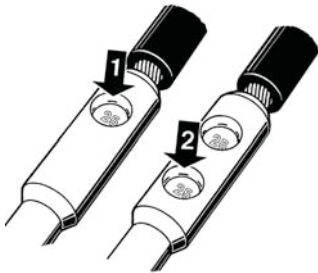

Crimp sequence.

Al through connectors without partition 300 - 400 mm²

- used mainly for connecting two Al conductors of the same size to each other
- two crimps on each side are necessary, crimp sequence see picture
- use special matrix 13P37M and special punch 13P37D, no matrix holder necessary



Cat. no. mm ² , Al-Cu	mm D	d	L	Rec. tool
AS300B	37	22,3	150	V1300
AS400B	37	25	150	V1300

For detailed information regarding recommended tool or system, see chapter 6.



AlCu bimetallic terminals 16 - 1200 mm²

- used primarily to connect Al conductors to Cu appliance studs, Cu bus bars, etc.
- two adjacent crimps are necessary - crimp sequence , see picture



Crimp sequence.

Cat. no. stranded, mm ²	Solid	mm W	d	N	N ₁	L	Pcs/ pack	Rec. tool	Note
AKK16-8	25 (16)	16,0	5,9	8,5	10,0	66	48	V1300	
AKK25-8	35	16,0	6,8	8,5	10,0	66	48	V1300	
AKK25-12	35	22	6,8	11,5	15,5	75	24	V1300	
AKK35-8	50	25	8,5	12,5	12,5	89	24	V1300	
AKK50-8	70	25	9,6	12,5	12,5	89	24	V1300	
AKK50-10	70	25	9,6	12,5	12,5	89	24	V1300	
AKK50-12	70	25	9,6	12,5	12,5	89	24	V1300	
AKK70-8	95	25	11,3	12,5	12,5	89	24	V1300	
AKK70-10	95	25	11,3	12,5	12,5	89	24	V1300	
AKK70-12	95	25	11,3	12,5	12,5	89	24	V1300	
AKK95-8	120	25	12,5	12,5	12,5	108	12	V1300	
AKK95-10	120	25	12,5	12,5	12,5	108	12	V1300	
AKK95-12	120	25	12,5	12,5	12,5	108	12	V1300	
AKK95-16	120	30	12,5	15,0	15,0	115	12	V1300	
AKK120-10	150	25	14,0	12,5	12,5	108	12	V1300	
AKK120-12	150	25	14,0	12,5	12,5	108	12	V1300	
AKK120-16	150	30	14,0	15,0	15,0	115	12	V1300	
AKK150-10	185	25	15,8	12,5	12,5	108	12	V1300	
AKK150-12	185	25	15,8	12,5	12,5	108	12	V1300	
AKK150-16	185	30	15,8	15,0	15,0	115	12	V1300	
AKK185-10	240	30	17,6	15,0	15,0	116	12	V1300	
AKK185-12	240	30	17,6	15,0	15,0	116	12	V1300	
AKK185-16	240	30	17,6	15,0	15,0	116	12	V1300	
AKK240-10		30	19,8	15,0	15,0	116	12	V1300, V250	
AKK240-12		30	19,8	15,0	15,0	116	12	V1300, V250	
AKK240-16		30	19,8	15,0	15,0	116	12	V1300, V250	
AKK300-12		37	22	18,5	18,5	154	6	V250	
AKK300-16		37	22	18,5	18,5	154	6	V250	
AKK300-20		37	22	18,5	18,5	154	6	V250	
AKK300-12SOLID		37	20	18,5	18,5	154	6	V250	
AKK300-16SOLID		37	20	18,5	18,5	154	6	V250	
AKK300-20SOLID		37	20	18,5	18,5	155	6	V250	
AKK400-12		37	25	18,5	18,5	155	6	V250	
AKK400-16		37	25	18,5	18,5	155	6	V250	
AKK400-20		37	25	18,5	18,5	155	6	V250	
AKK500A-16		48	28	18,5	18,5	222	3	V250	4
AKK500A-20		48	28	26	29	222	3	V250	4
AKK500A-1		48	28	70*		237		V250	2
AKK500A-2		70	28	70*		239		V250	2
AKK500B-16		42	28	21	21	174	3	V250	5
AKK500B-20		42	28	21	21	174	3	V250	5
AKK500B-1		42	28	70*		202	3	V250	2
AKK500B-2		70	28	70*		211		V250	2
AKK630A-1		48	32	70*		237	3	V250	1,2
AKK630A-2		70	32	70*		239		V250	1,2
AKK800-1		62	36	70*		263		V1470	1,2
AKK800-2		75	36	75*		275		V1470	1,2
AKK1000-1		62	40	70*		263		V1470	1,2
AKK1000-2		75	40	75*		275		V1470	1,2
AKK1200		75	44	75*		310		V1470	1,2

* the full palm length

For detailed information regarding recommended tool or system, see chapter 6.



AlCu bimetallic terminals 300 - 400 mm²

- used primarily to connect Al conductors to Cu appliance studs, Cu bus bars, etc.
- two adjacent crimps are necessary - crimp sequence, see pictures
- when crimping Al part, use special matrix 13P37M and special punch 13P37D, no matrix holder necessary

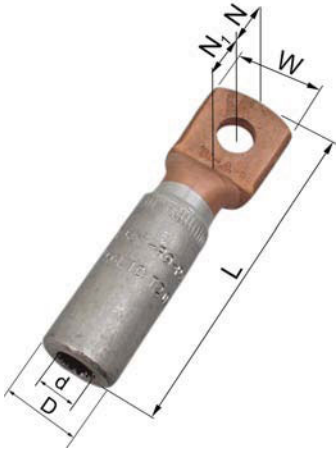

Cat. no. mm ² , Al-Cu	mm W	D	d	N	N ₁	L	Rec. tool
AKK300B-12	37	37	22,3	18,5	18,5	139	V1300
AKK300B-16	37	37	22,3	18,5	18,5	139	V1300
AKK400B-16	37	37	25	18,5	18,5	139	V1300
AKK400BA-16	37	37	26	18,5	18,5	139	V1300
AKK400B-12	37	37	25	18,5	18,5	139	V1300

AlCu pin terminals bimetallic 16 - 300 mm²

- used to connect Al conductors to mechanical clamp type connections for round Cu pins.
- two adjacent crimps are necessary - crimp sequence, see picture



Cat. no. stranded, mm ²	Solid mm ²	mm e	d	D	L ₁	L	Pcs/ pack	Rec. tool
AKP16	25 (16)	6,0	5,9	13,0	25	56	48	V1300
AKP25	35	6,0	6,8	13,0	25	56	48	V1300
AKP35	50	9,0	8,5	20	25	78	24	V1300
AKP50	70	9,0	9,6	20	35	88	24	V1300
AKP70	95	9,0	11,3	20	35	88	24	V1300
AKP95	120	12,0	12,5	25	35	103	24	V1300
AKP120	150	12,0	14,0	25	40	108	24	V1300
AKP150	185	12,0	15,8	25	40	108	24	V1300
AKP185	240	14,0	17,6	32	45	113	12	V1300
AKP240		14,0	19,8	32	45	113	12	V1300, V250
AKP300		16,0	22	36	50	143	9	V250

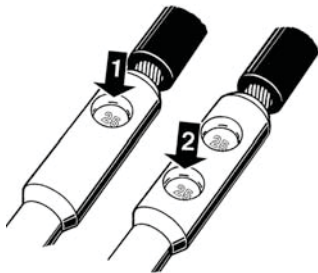

Crimp sequence.

Transition connectors for Al conductors 16 - 95 mm² to Cu solid conductors 10 mm²

- adapter connector from stranded Al conductor to solid Cu conductor 10 mm² (e.g. Excel, Excelett)
- two crimps are necessary for both Al and Cu, crimp sequence see picture (equal order for Cu)



Cat. no. mm ² , Al-Cu	Solid Al mm ²	mm d	d ₁	L	Pcs/ pack	Rec. tool	Note
AKS16-10S	25 (16)	5,9	4,5	64	48	V1300	1
AKS25-10S	35	6,8	4,5	64	48	V1300	1
AKS35-10S	50	8,5	4,5	86	48	V1300	1
AKS50-10S	70	9,6	4,5	86	24	V1300	1
AKS70-10S	95	11,3	4,5	86	24	V1300	1
AKS95-10S	120	12,5	4,5	101	24	V1300	1

Note

1. Make two crimps also on the Cu side.

For detailed information regarding recommended tool or system, see chapter 6.



AlCu bimetal through connectors 16 - 400 mm²

- connect Al conductors to Cu conductors
- stranded/solid Al conductors, stranded/flexible Cu conductor
- two adjacent crimps for Al, see picture; normally one for Cu
- when crimping the Cu part, place the dies between the circular groove on the Cu barrel and the edge

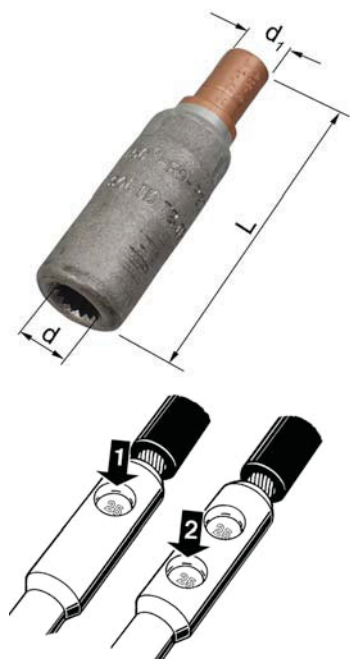

Crimp sequence.

Cat. no. mm ² , Al-Cu	Solid Al mm ²	mm d	d ₁	L	Pcs/ pack	Rec. tool
AKS16-10	25 (16)	5,9	5,0	46	48	V1300
AKS25-10	35	6,8	5,0	46	48	V1300
AKS25-16	35	6,8	6,0	46	48	V1300
AKS35-10	50	8,5	5,0	66	24	V1300
AKS35-16	50	8,5	6,0	66	24	V1300
AKS35-25	50	8,5	8,0	69	24	V1300
AKS50-10	70	9,6	5,0	66	24	V1300
AKS50-16	70	9,6	6,0	66	24	V1300
AKS50-25	70	9,6	8,0	69	24	V1300
AKS50-35	70	9,6	9,0	71	24	V1300
AKS50-50	70	9,6	11,0	76	24	V1300
AKS70-35	95	11,3	9,0	71	24	V1300
AKS70-50	95	11,3	11,0	76	24	V1300
AKS70-70	95	11,3	13,0	78	24	V1300
AKS95-10	120	12,5	5,0	81	24	V1300
AKS95-16	120	12,5	6,0	81	24	V1300
AKS95-25	120	12,5	8,0	84	24	V1300
AKS95-35	120	12,5	9,0	86	24	V1300
AKS95-50	120	12,5	11,0	91	24	V1300
AKS95-70	120	12,5	13,0	93	24	V1300
AKS95-95	120	12,5	15,0	94	24	V1300
AKS120-50	150	14,0	11,0	91	24	V1300
AKS120-70	150	14,0	13,0	93	24	V1300
AKS120-95	150	14,0	15,0	94	24	V1300
AKS120-120	150	14,0	17,0	98	24	V1300
AKS150-25	185	15,8	8,0	84	24	V1300
AKS150-35	185	15,8	9,0	86	24	V1300
AKS150-50	185	15,8	11,0	91	24	V1300
AKS150-70	185	15,8	13,0	93	24	V1300
AKS150-95	185	15,8	15,0	94	24	V1300
AKS150-120	185	15,8	17,0	99	24	V1300
AKS150-150	185	15,8	19,0	99	24	V1300
AKS185-95	240	17,6	15,0	94	12	V1300
AKS185-120	240	17,6	17,0	99	12	V1300
AKS185-150	240	17,6	19,0	100	12	V1300
AKS185-185	240	17,6	21	100	12	V1300
AKS240-35		19,8	9,0	87	12	V1300, V250
AKS240-50		19,8	11,0	91	12	V1300, V250
AKS240-70		19,8	13,0	94	12	V1300, V250
AKS240-95		19,8	15,0	94	12	V1300, V250
AKS240-120		19,8	17,0	99	12	V1300, V250
AKS240-150		19,8	19,0	100	12	V1300, V250
AKS240-185		19,8	21	100	12	V1300, V250
AKS240-240A		19,8	22,5	100	12	V1300, V250
AKS300-150		22	19,0	124	9	V250
AKS300-185		22	21	124	9	V250
AKS300-240A		22	22,5	125	9	V250
AKS400-150		25	19,0	124	6	V250
AKS400-185		25	21	124	6	V250
AKS400-240A		25	22,5	124	6	V250
AKS400-300A		25	24,5	125	6	V250

For detailed information regarding recommended tool or system, see chapter 6.



AlCu bimetallic through connectors 300 - 400 mm²

- connect Al conductors to Cu conductors
- stranded/solid Al conductors, stranded/flexible Cu conductor
- two adjacent crimps are necessary - crimp sequence, see pictures
- when crimping Al part, use special matrix 13P37M and special punch 13P37D, no matrix holder necessary
- when crimping Cu part, use special dies 13B30, no die holder necessary
- when crimping the Cu part, place the dies between the circular groove on the Cu barrel and the edge



Cat. no., mm ² , Al-Cu	mm d	D	d ₁	L	Rec. tool
AKS300B-240A	22,3	37	29	111	V1300
AKS400B-240A	25	37	29	111	V1300

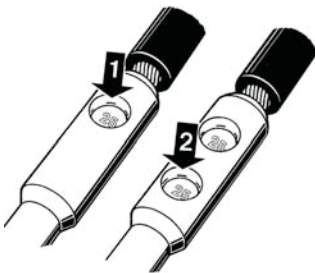

Crimp sequence.

For detailed information regarding recommended tool or system, see chapter 6.



Notes



Tools for crimping Cu, Al-/Cu terminals and connectors

Tools for Cu terminals 4 - 120 mm²	3
ELPRESS Mini PV350, battery powered crimp tool	5
SYSTEM 600 for Cu terminals 10 - 240 mm², Al terminals 16 - 25 mm² (-35 solid) mm² and C-sleeves 6 - 50 mm²	6
SYSTEM 1300 for Cu terminals and connectors 10 - 400 mm², C sleeves 6 - 120 mm² and Al terminals and connectors 16 - 400 mm²	10
Patented DUAL SYSTEM for crimping flexible conductors in KRF/KSF- connectors for demanding applications, 10 - 300 mm²	20
SYSTEM V250 for crimping Cu terminals and connectors 10 - 800 mm², C-sleeves up to 300 mm² and Al terminals and connectors 16 - 630 mm²	23
CS2500 crimp station for high volume cable harness production, KRF/KSF-terminals 10 - 300 mm²	30
Analyzer, software for analysis of crimps and system calibration	31
SYSTEM V1470 for Cu terminals and connectors 500 - 1000 mm², C-sleeves 185 - 300 mm², Al terminals and connectors 800 - 1200 mm²	32
P4000, hydraulic foot pump	34
P1000, mains powered pump for industrial use	35
PS710, light weight and handy pump designed according to customer request	36

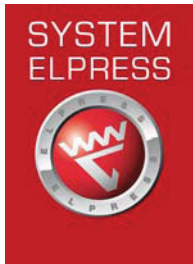

System Elpress

System Elpress consists of connectors and tools tested together for optimum connection result. The System concept makes you as a customer able to feel secure when using our system and to be sure a safe connections is made when Elpress products are used correctly.

Hydraulic crimp systems



Crimping with Elpress crimp tool PVL1300.

Elpress hydraulic crimp systems fit Elpress terminals and connectors from 10 to 1200 mm². The systems comprise either pumps and crimp heads which can be freely combined or by complete hand held tools where these functions are integrated.

For crimping, prerounding of sectorised conductors, cable cutting, etc. there are a variety of accessories. Together with matching terminals the complete crimp system is formed. Both pumps and manual tools have, with a few exceptions, fast feed function that allows the actual crimping to start after the dies have rapidly been brought in contact with the terminal. There is also a full-closure function to safe-guard a complete crimp action.

V1300-system



Cu terminals

V1300 system for crimping of Cu terminals 10-400 mm². The V1300-system is also available in a C-version with an open head for crimping of Cu terminals in narrow spaces.



Al terminals

V1300 system for crimping of Al terminals and prerounding of Al conductors 16-400 mm². Prerounding is done on sector-shaped Al conductors.

V250-system



Cu terminals

V250-system for crimping of Cu terminals 10-800 mm².



Al terminals

V250-system for crimping of Al terminals and prerounding of Al conductors 16-630 mm². Prerounding is done on sector-shaped Al conductors.



Crimping with Elpress crimp tool PVL611.



Tools for Cu terminals 4 - 120 mm²

Crimp range 4 - 25 mm²

Particulars:

- certified tool for norm compliant connection
- 30% lower handforce than earlier T2258 version makes crimping easier
- ergonomic handles makes installation easier
- scissor movement for optimal access in narrow spaces
- ratchet release which is not released until the crimping is completed
- hexagonal crimping with clearly marked crimping dies
- calibration adjustment possible

ES2258

Certified crimping tool for crimping of Cu terminals, CUT 6-16 mm² and KR/KS 4-10 mm². **ES2258 replaces T2258.**

Particulars:

- weight 0.65 kg, length 300 mm

ES2258



Crimp type



EL2258



Crimp type



ES2288



Crimp type



EL2258

Certified crimping tool for crimping of Cu terminals, KRF/KSF 16-25 mm².

Particulars:

- weight 0.65 kg, length 300 mm

ES2288

Certified crimping tool for crimping of Cu terminals, KRT/KST 10-25 mm².

Particulars:

- weight 0.65 kg, length 300 mm



Crimp range 10 - 70/95 mm²

T3165A1/T3165B/T3165C

T3165A1/T3165B/T3165C



Crimp type



Elpress crimp tool for crimping of Cu terminals and connectors:

T3165A1: KR/KRF/KS/KSF, 10-70 mm².

T3165B: KR/KRD/KS/KSD, 10-95 mm².

T3165C: KRT/KST, 10-95 mm².

Particulars:

- equipped with full closure mechanism
- crimp wheel of rolled steel which gives high durability
- weight 3.0 kg, length 500 mm
- crimp force up to approximately 35 kN
- calibration adjustment possible

Crimp range 6 - 50 mm²

TH0650T

TH0650T



Crimp type



Mechanical handtool for crimping of Cu terminals type KRT/KST up to 50 mm².

Particulars:

- rotating crimp wheel
- weight 1.5 kg, length 400 mm
- no full closure mechanism

Crimp range 10 - 120 mm²

TH10120T

TH120T



Crimp type



Mechanical handtool for crimping of Cu terminals type KRT/KST up to 120 mm².

Particulars:

- rotating crimp wheel
- weight 3.7 kg, length 650 mm
- no full closure mechanism



Battery powered crimp tool for Cu terminals and connectors 10 - 95 mm²

PV350



Crimp range 10 - 95 mm²

PV350 - Elpress Mini

Battery powered crimp tool for crimping of Cu terminals and connectors up to 95 mm². Separate, special dies to be used in accordance with table below.

Particulars:

- hexagonal crimping up to 95 mm²
- easy-to-open crimp head for rapid die change
- slim ergonomic design - good accessibility even in confined areas
- NiMh batteries (9.6 V, 2.0 Ah), charge time approx. 40 minutes
- rapid crimp operation 2-4 seconds
- approx. 100 - 150 crimps per battery charge (depending on temperature, frequency, etc.)
- for service and installation use
- weight 1.6 kg
- length 360 mm

Crimp types



Die pair MB11 for PV350.

Crimp dies for PV350

Supplied in pairs.

For hexagonal crimping of copper terminals and connectors

mm ²	For KR/KRF KS/KSF		For KR/KRD KS/KSD		For KRT/KST	
	Die No.	No. of crimps	Die No.	No. of crimps	Die No.	No. of crimps
10; (KR/KS types)	MB8	1	MB8	1	MB7	1
16	MB9	1	MB8	1	MB8.5	1
25	MB11	2	MB9	1	MB10	2
35	MB13	2	MB11	2	MB12	2
50	MB14,5	2	MB12	2	MB14	3
70	MB17	3	MB14	3	MB16	3
95	-	-	MB17	3	-	-
For C-sleeves						
10-6 / 10-6 mm ²	MBC4	1	-	-	-	-

For solid conductors, type CUT 6-16 mm² and KR/KS-connectors 4-10 mm².

Area		Die	No. of crimps
CUT-connectors 6-16 mm ²	KR/KS-terminals 4-10 mm ²	MB4016	1



Die pair MBC4, for C-sleeves.



Tools for Cu terminals 10 - 240 mm², Al terminals 16- 25 mm² (-35 solid) mm² and C-sleeves 6 - 50 mm²

T2600/T2600B/T2600C

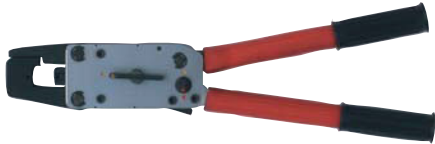

Crimp types



EIPRESS		Hexagon	KSF	KRF	↓
	TB	8	10	1	
		9	16	1	
		11	25	1	
		13	35	1	
		14,5	50	1	
		17	70	2	
	20	95	2		
			C		↓
			C4	1	
			C5	1	
			C6	1	
			C8-9	2	

Information label for crimp tools T2600.

T2600/T2600B/T2600C

Mechanical handtool for crimping of Cu- and Al terminals:
T2600 for crimping of Cu terminals type KRF/KSF 10-95 mm²
T2600B for crimping of Cu terminals type KRK/KSD 10-120 mm²
T2600C for crimping of Cu terminals type KRT/KST 10-120 mm²

Particulars:

- rapid opening enables easy die change and quick removal after jointing
- crimp die (TB7) is available for solid 10 mm² Cu-connector, (for EXCL-type cable or similar)
- crimp force up to 57 kN
- rapid die closure and minimum handle force
- easy to operate in confined spaces
- only four dies are required to crimp 10 - 120 mm² Cu (KRD/KRT)
- rapid feed function
- supplied in a metal box
- equipped with full closure mechanism
- weight 1.9 kg
- length 440 mm, width 140 mm

V600



Crimp types



V600

Crimp head for crimping Cu terminals of type KRF/KSF 10–150 mm², KRK/KSD 10-185 mm², KRT/KST 10-240 mm² and C-sleeves up to 50/50 mm². Used together with footpump P4000, battery / mains powered pump PS710 and mains powered pump P1000.

Particulars:

- crimping force 55 kN
- robust textile bag with room for 10 die pairs
- weight 2.1 kg
- dimensions 189 x 53 x 74 mm



V611



Crimp types



V611

Hydraulic tool for crimping of Cu terminals type KRF/KSF 10-150 mm², KRD/KSD 10-185 mm², KRT/KST 10-240 mm² and C-sleeves up to 50/50 mm². Uses the same dies as T2600, V600 and PVL611.

Particulars:

- two-step, fast feed piston movement to crimp engagement which makes the crimp cycle shorter
- crimp force 60 kN
- supplied in a robust textile bag with foam rubber insert
- weight 2.5 kg
- dimensions 425 x 115 x 53 mm

PVL611

PVL611DB, supplied with 2 batteries

PVL611-US, supplied with 115 VAC charger

PVL611



Crimp types



Battery crimp tool for crimping of Cu terminals type KRF/KSF 10-150 mm², KRD/KSD 10-185 mm² and KRT/KST 10-240 mm² and C-sleeves up to 50/50 mm². Uses the same dies as T2600, V600 and V611.

Particulars:

- flexible and ergonomic design
- buzzing signal and flashing light if right pressure is not achieved
- LED lightning for work in dark environments
- possibility to document each crimp for unique service control
- crimp force 55 kN (6 ton)
- crimps/charge: 100-200 depending on size and temperature
- crimp time: 3-6 s depending on size
- working temperature -20°C to +40°C
- environmental friendly battery, Li-Ion Makita, 1.3 Ah, 18V
- 230 VAC battery charger Li-Ion Makita, charging time 15 min
- LED indication of charge status
- for service and installation use
- supplied with robust plastic case, battery, charger and instruction manual
- weight 2.5 kg, (incl battery)
- dimensions 387 x 116 x 75 mm



Accessories for tool types T2600, V600, V611 and PVL611

- Note that KRF terminals may be used on flexible (IEC60228, class 5) as well as stranded (class 2) conductors and that KR D and KRT terminals are used on stranded conductors.
- Be sure to use dies exactly matching the terminal.

Crimp dies

Supplied as a pair. For hexagonal crimping of Cu terminals and connectors.
Note: KB dies are for V600, V611 and PVL611 only.



TB dies.



KB dies.

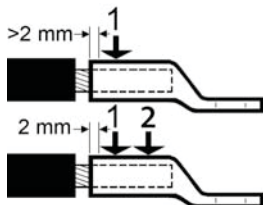

One and two crimps.

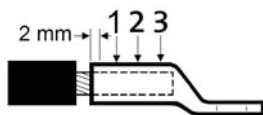

Three crimps.

KRF/KSF		
mm ²	Dies	No. of crimps
10 and 70	TB8-17	1 resp.2
16 and 35	TB9-13	1
25 and 50	TB11-14,5	1
10 and 95	TB7 ¹ -20	1 resp.2
120	KB22	3
150	KB25	3

¹ TB7 special for crimping KRX-terminals and KSX-connectors

² For terminals type KR10 and connectors type KS10

KRD/KSD		
mm ²	Dies	No. of crimps
10 ² /16 and 70	TB8-14	1
25 and 50	TB9-12	1
35 and 95	TB11-16	1 resp.2
10 ¹ and 120	TB7 ¹ -19	1 resp.2
150	KB22	3
185	KB25	3

¹ TB7 special for crimping KRX-terminals and KSX-connectors

² For terminals type KR10 and connectors type KS10

KRT/KST		
mm ²	Dies	No. of crimps
10 ¹ and 120	TB7-19	1 resp.2
10 ² and 95	TB8-18	1 resp.2
16 and 95	TB8,5-18	1 resp.2
25 and 70	TB10-16	1 resp.2
35 and 50	TB12-14	1
150	KB22	3
185	KB24	3
240	KB26	3

¹ TB7 is also for crimping KRX-terminals and KSX-connectors

² For terminals type KR10 and connectors type KS10

DIN 46235		
mm ²	Dies	No. of crimps
10-16	TB6-8DIN	1
25-35	TB10-12DIN	1
50-70	TB14-16DIN	1 resp.2
95	TB18DIN	1 resp.2



TBNP dies.

For **overhead line connectors** for alloy Al conductors, hexagonal crimping.

mm ²	Dies	No. of crimps
31-99	TBNP16-20	Die side 16: 2x5 Die side 20: 2x10



TBC dies.

For Cu, branch connectors (C-sleeves), oval crimping.

Dies	Main conductor mm ²	Branch mm ²	Crimp in die nest	No. of crimps
TBC4-C8-9	10-6	10-6	C4*	1
	50-16	50-16	C8-9	2
TBC5-C6	16-10	16-6	C5	1
	25-16	25-16	C6	1

* Die nest marked C4A to be used for 6 mm² main to 6 mm² branch.

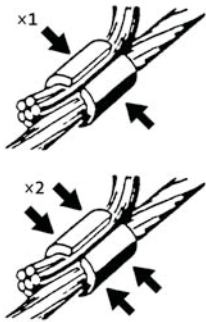

One resp. two crimps.



Matrix holder TV2620, matrix TP13M and punch TP13D.

Punch and matrix

For Al terminals and connectors, indent crimping.

Stranded mm ²	Solid mm ²	Matrix holder	Matrix	Punch
16-25	16-35	TV2620	TP13M	TP13D

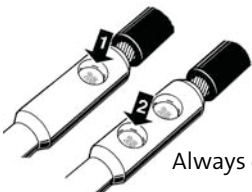

Always crimp twice on Al.



SYSTEM 1300 for Cu terminals and connectors 10 - 400 mm², C-sleeves 6 - 120 mm² and Al terminals and connectors 16 - 400 mm²

V1300



Crimp types



V1300

Crimp head for crimping of Cu terminals type KRF/KSF 10-400 mm², KR D/KSD 10-400 mm², KRT/KST 10-400 mm², C-sleeves up to 120 mm², Al terminals and connectors 16-240 mm². Used with footpump P4000, battery / mains powered pump PS710 or mains powered pump P1000.

Particulars:

- equipped with oil spray safety protection cap
- light and flexible steel crimp head
- special nitrogen anti-corrosion surface treatment
- working pressure 63 MPa (630 bar)
- crimp force 130 kN (13 tons)
- weight 3.7 kg, excl. accessories
- length 270 mm, incl. quick coupling, width 82 mm

V1311



Crimp types



V1311

Hydraulic handtool for crimping of Cu terminals type KRF/KSF 10-400 mm², KR D/KSD 10-400 mm², KRT/KST 10-400 mm², C-sleeves up to 120 mm², Al-terminals and connectors 16-240 mm². Uses the same accessories as for V1300 above.

Particulars:

- automatic fast forward action
- requires low hand force, about 245 N at max. force
- crimp force 130 kN (13 tons)
- weight 4.9 kg, excl. accessories, length 590 mm

PVL1300



Crimp types



PVL1300

PVL1300DB, supplied with 2 batteries

PVL1300-US, supplied with 115 VAC charger

Battery powered crimp tool for crimping of Cu terminals type KRF/KSF 10-400 mm², KR D/KSD 10-400 mm², KRT/KST 10-400 mm², C-sleeves up to 120 mm², Al terminals and connectors 16-240 mm². Uses the same crimp accessories as the other products in the above V1300 System.

Particulars:

- ergonomic design that optimizes the balance of the tool in the users hand
- buzzing signal and flashing light if right pressure is not achieved
- LED lightning for work in dark environments
- possibility to document each crimp for unique service control
- for service and installation use
- crimp force 124 kN (13 ton)
- crimps/charge: 60-120 depending on size and temperature
- crimp time: 4-12 s depending on size
- working temperature -20°C to +40°C
- environmental friendly battery, Li-Ion Makita, 3.0 Ah, 18V
- 230VAC battery charger Li-Ion Makita, charging time 22 min
- LED indication of charge status
- supplied with robust plastic case, battery, charger and instruction
- weight 5.4 kg, (incl battery), dimensions 412 x 319 x 75 mm



Accessories for crimping Cu with V1300, V1311 and PVL1300



V1318 + B type dies + V1316.



Integrated dies 13B38.

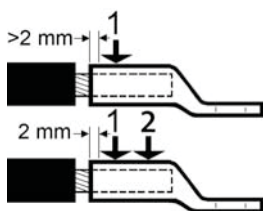

One and two crimps.

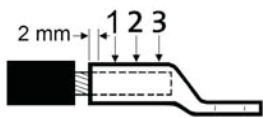

Three crimps.

- Note that KRF terminals may be used on flexible (IEC60228, class 5) as well as stranded (class 2) conductors and that KRD and KRT terminals are used on stranded conductors.
- Be sure to use dies exactly matching the terminal.

Crimp dies

Supplied as a pair. For hexagonal crimping of Cu terminals and connectors.
If not indicated otherwise, always use inner die holder V1316 and outer die holder V1318.

Cat. no.	Description
V1316	Inner die holder
V1318	Outer die holder

KRF/KSF		
mm ²	Dies	No. of crimps
10	B8	1
16	B9	1
25	B11	1
35	B13	1
50	B14,5	1
70	B17	1
95	B20	1
120	B22	1
120	13B22*	2
150	B25	1
150	13B25*	2
185	13B27*	2
240	13B30*	2
300	13B32*	2
400	13B38*	3

* All dies type 13Bxx are used without die holder.

KRD/KSD		
mm ²	Dies	No. of crimps
10	B8	1
16	B8	1
25	B9	1
35	B11	1
50	B12	1
70	B14	1
95	B16	1
120	B19	1
150	B22	1
185	13B25*	2
240	13B27*	2
300	13B30*	2
400	13B32*	2

* All dies type 13Bxx are used without die holder.





V1318 + B type dies + V1316.

KRT/KST		
mm ²	Dies	No. of crimps
10	B7	1
16	B8.5	1
25	B10	1
35	B12	1
50	B14	1
70	B16	1
95	B18	1
120	B19	1
150	B22	1
185	B24	1
240	13B26*	2
300	13B30*	2
400	13B32*	2

* All dies type **13Bxx** are used **without die holder**.



V1318 + BC type dies + V1316.

DIN 46235		
mm ²	Dies	No. of crimps
10	B6DIN	1
16	B8DIN	1
25	B10DIN	1
35	B12DIN	1
50	B14DIN	1
70	B16DIN	1
95	B18DIN	1
120	B20DIN	1
150	B22DIN	1
185	13B25DIN*	2
240	13B28DIN*	2
300	13B32DIN*	3

* All dies type **13Bxx** are used **without die holder**.

For oval crimping of Cu branch connectors (C-sleeves).

If not indicated otherwise, always use inner die holder **V1316** and outer die holder **V1318**.

Through conductor mm ²	Branch mm ²	Dies	No. of crimps
10-6	10-6	BC4**	1
16-10	16-10	BC5	1
25-16	25-16	BC6	1
50-16	50-16	BC8-9	1
70-50	70-25	BC11	1
95-70	95-25	13BC13*	2
120-95	120-25	13BC15*	2

* Are used without die holders; make two crimps, see picture.

** Die nest must be marked C4A to connect 6 mm² main to 6 mm² branch.

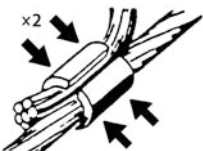
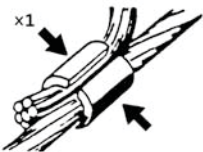

One or two crimps made.



Storage box LV1300B

Carry box which takes the tool V1300 and all necessary accessories to crimp Elpress Cu terminals and through connectors.

LV1300B



Particulars:

- steel reinforced plywood
- polyethylen insert material
- the box can be used as storage or be taken to site
- sturdy, form cut inserts
- weight 5.2 kg, excl. accessories
- length 570 mm, width 467 mm, height 130 mm.



Accessories for crimping Al with V1300, V1311 and PVL1300

- When crimping Al terminals and connectors, two indent crimps are always made, see picture.

Punch and matrix

For indent crimping of Al terminals and connectors.

For 16 - 150 (185 solid) mm², matrix holder V1320 is used.



V1320 matrix holder + P13M matrix + P13D punch.

Cat. no.	Description
V1320	Matrix holder

Stranded mm ²	Solid mm ²	Matrix	Punch
16	16(+25)	P13M	P13D
25	35	P13M	P13D
35	50	P20M	P20D
50	70	P20M	P20D
70	95	P20M	P20D
95	120	P25M	P25D
120	150	P25M	P25D
150	185	P25M	P25D
185	240	13P32M*	P32D
240		13P32M*	P32D

* Used without matrix holder.

Always make two crimps, see picture.

For indent crimping of Al terminals type AKKxxxB/AKSxxxB and connectors type ASxxxB.

Stranded mm ²	Matrix	Punch
300	13P37M*	13P37D
400	13P37M*	13P37D

* Used without matrix holder.

Always make two crimps, see picture.

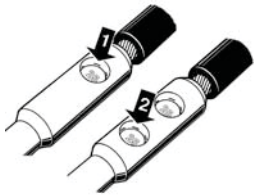

Crimp sequence.



For prerounding of sector shaped Al conductors.
For 16 - 240 mm², matrix holder **V1320** is used.

Stranded mm ²	Solid mm ²	Matrix	Punch
16	16(+25)	R6MR	13R6DR
25	35	R7MR	13R7DR
35	50	R8MR	13R8DR
50	70	R9MR	13R9DR
70	95	R12MR	13R12DR
95	120	R13MR	13R13DR
120	150	R15MR	13R15DR
150	185	R16MR	13R16DR
185	240	13R18MR*	13R18DR
240		13R20MR*	13R20DR

* Used without matrix holder.

Matrix holder V1320 + matrix R6MR
+ punch 13R6DR.

L-Alu



Storage box L-Alu

Complementary carry box to LV1300B and LV250 which takes all necessary accessories to crimp Elpress Al- terminals and through connectors.

Particulars:

- steel reinforced plywood
- polyethylen insert material
- the box can be used as storage or be taken to site
- sturdy, form cut inserts
- weight 5.2 kg, excl. accessories
- length 570 mm, width 467 mm, height 130 mm.



Accessories for crimping overhead line connectors with V1300, V1311 and PVL1300

Crimp dies

Supplied as a pair.

For hexagonal crimping of connectors for overhead conductors of AlMgSi (Super B) and Al 59.



mm ²	Inner die holder	Outer die holder	Dies	No. of crimps
31-62	V1316	V1318	B16NP	2x5
99	V1316	V1318	B20NP	2x5
157			13B26*	2x16
241			13B32*	2x16

* Used without die holders.

Supplied as a pair.

For hexagonal crimping of connectors for overhead ACSR conductors.

Die holders V1316 and V1318 to be used.

mm ²	Steel connector (inner)		Al-connector (outer)	
	Dies	No. of crimps	Dies	No. of crimps
62	B6FE	2x5	B16NP	2x5
99	B8FE	2x5	B20NP	2x5

V1318 outer die holder + BNP type dies + V1316 inner die holder.



C-type crimp head for Cu 10 - 400 mm² (KRF 300 mm²)

V1300C



Crimp types



V1300C

Crimp head for crimping of Cu terminals type KRF/KSF 10-300 mm², KR D/KSD 10-400 mm², KRT/KST 10-400 mm² and C-sleeves up to 120 mm². Used with footpump P4000 or battery / mains powered pump PS710.

Particulars:

- equipped with oil spray safety protection cap
- working pressure 63 MPa (630 bar)
- crimp force 130 kN
- flexible and easy to operate
- weight 4.2 kg, excl accessories
- length 295 mm, incl fork and quick coupling, width 145 mm

V1311C



Crimp types



V1311C

Hydraulic handtool for crimping of Cu terminals type KRF/KSF 10-300 mm², KR D/KSD 10-400 mm², KRT/KST 10-400 mm² and C-sleeves up to 120 mm². Uses the same die system as V1300C above.

Particulars:

- automatic two-step fast feed system
- full closure system which guarantees a complete crimp
- the fork is rotatable 180°
- crimp force 130 kN
- ergonomically shaped handles
- easy to carry and operate
- covers the common needs of Cu-crimping for electricity utilities
- carry box
- weight 6.4 kg, excl accessories
- length 620 mm



Carry box supplied with V1311 and V1311C.



Accessories for Cu crimping with V1300C and V1311C

- Note that KRF terminals may be used on flexible (IEC60228, class 5) as well as stranded (class 2) conductors and that KRD and KRT terminals are used on stranded conductors.
- Be sure to use dies exactly matching the terminal.
- Die holder V1330 is designed to allow crimping of straight as well as angular terminals.

Crimp dies

Supplied as a pair.

For hexagonal crimping of Cu terminals.

If not otherwise indicated, use **die holder V1330**.



Die holders V1330 (pair).



B type dies.

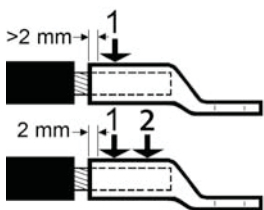

One and two crimps.

Cat. no.	Description
V1330	Die holder

KRF/KSF		
mm ²	Dies	No. of crimps
10	B8	1
16	B9	1
25	B11	1
35	B13	1
50	B14,5	1
70	B17	1
95	B20	1
120	B22	1
150	B25	1
185	13CB27*	2
240	13CB30*	2
300	13CB32*	2

* All dies type **13Bxx** are used **without die holders**.

KRD/KSD		
mm ²	Dies	No. of crimps
10	B8	1
16	B8	1
25	B9	1
35	B11	1
50	B12	1
70	B14	1
95	B16	1
120	B19	1
150	B22	1
185	13CB25*	2
240	13CB27*	2
300	13CB30*	2
400	13CB32*	2

* All dies type **13Bxx** are used **without die holders**.



KRT/KST		
mm ²	Dies	No. of crimps
10	B7	1
16	B8,5	1
25	B10	1
35	B12	1
50	B14	1
70	B16	1
95	B18	1
120	B19	1
150	B22	1
185	13CB24*	2
240	13CB26*	2
300	13CB30*	2
400	13CB32*	2

* All dies type **13Bxx** are used **without die holders**.

Dies for industrial use, integrated, used without die holders.



Integrated dies 13CB20.

mm ²	Dies for KRF/KSF	No. of crimps
10	13CB8	1
16	13CB9	1
25	13CB11	1
35	13CB13	1
50	13CB14,5	1
70	13CB17	1
95	13CB20	1
120	13CB22	1
150	13CB25	2
185	13CB27	2
240	13CB30	2
300	13CB32	2

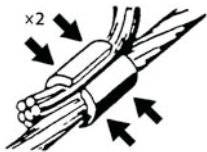
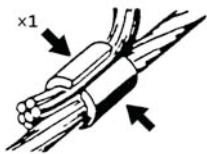

One or two crimps.

DIN 46235		
mm ²	Dies	No. of crimps
10	B6DIN	1
16	B8DIN	1
25	B10DIN	1
35	B12DIN	1
50	B14DIN	1
70	B16DIN	1
95	B18DIN	1
120	B20DIN	1
150	B22DIN	1

For oval crimping of Cu branch connectors (C-sleeves).
If not otherwise indicated, use die holder **V1330**.



BC type dies.

Main conductor mm ²	Branch mm ²	Dies	No. of crimps
10-6	10-6	BC4**	1
16-10	16-10	BC5	1
25-16	25-16	BC6	1
50-16	50-16	BC8-9	1
70-50	70-25	BC11	1
95-70	95-25	13CBC13*	2
120-95	120-25	13CBC15**	2

* Used without die holders.

** Die nest must be marked C4A to connect 6 mm² main to 6 mm² branch.



Patented DUAL SYSTEM for crimping flexible Cu-conductors in KRF/KSF-connectors for demanding applications, 10 - 300 mm²

Particulars:

- patented crimp technique
- for crimping of flexible Cu terminals according to IEC60228, type class 5
- crimps terminals type KRF and through connectors type KSF
- for extra tough environments like cars and train, where the connections beside normal electrical properties also must meet demands related to corrosion, mechanical strength and vibration
- meet the requirements in IEC/EN 61238:1
- meet the requirements of corrosion according to DIN V 40 046, part 37
- meet the requirements for vibration according to EN 50 155
- meet the requirements of mechanical strength according to SEN 24 50 10



Crimp sequence

The crimp starts with an optimized hexagonal crimp and then makes a small indent in the same crimp cycle to further improve gas tightness as well as electrical and mechanical properties.

PVL1300DUAL

PVL1300DUAL-US, supplied with a 115 VAC charger

PVL1300DUAL



Crimp types



Battery powered crimp tool for crimping of type KRF/KSF 10-300 mm² in demanding applications.

Particulars:

- ergonomic design that optimizes the balance of the tool in the users hand
- buzzing signal and flashing light if right pressure is not achieved
- LED lightning for work in dark environments
- possibility to document each crimp for unique service control
- crimp force 124 kN (13 ton)
- crimps/charge: 60-120 depending on size and temperature
- crimp time: 4-12 s depending on size
- working temperature -20°C to +40°C
- environmental friendly battery, Li-Ion Makita, 3.0 Ah, 18V
- battery charger Li-Ion Makita, charging time 22 min
- LED indication of charge status
- for service and installation use
- supplied with robust plastic case, battery, charger and instruction
- PVL1300DB, supplied with 2 batteries
- weight 5.4 kg, (incl battery)
- dimensions 412 x 319 x 75

Accessories:

- PVBP-LI-ION 3Ah, 18 V Li-Ion, extra battery



DV1300

Crimp head for crimping of Cu terminals type KRF/KSF 10 - 300 mm². Used with footpump P4000 or battery / mains powered pump PS710.



DV1300



Crimp geometries



DUAL+regular crimps

Particulars:

- crimp head with the patented DUAL CRIMP technique which starts with an optimized hexagonal crimp and then makes a small indent in the same crimp cycle to further improve gas tightness as well as electrical and mechanical properties
- DUAL dies are available for 10 - 300 mm²
- crimps terminals type KRF and through connectors type KSF
- conventional accessories as shown for V1300 can be used (without DUAL-function)
- DV1300 can also be used with regular crimp dies for the 1300-system
- no die holders are necessary when using DUAL dies
- weight 3.4 kg
- dimensions Ø 74 mm x 265 mm

DV1300C

C-fork type crimp head, open to one side, for crimping of Cu terminals type KRF/KSF 10 - 300 mm². Used with footpump P4000 or battery / mains powered pump PS710.

DV1300C



Crimp geometries



DUAL + regular crimps

Particulars:

- Crimp head with the patented DUAL CRIMP technique which starts with an optimized hexagonal crimp and then makes a small indent in the same crimp cycle to further improve gas tightness as well as electrical and mechanical properties
- DUAL dies are available for 10 - 300 mm²
- crimps terminals type KRF and through connectors type KSF
- conventional dies as for V1300C can be used (without DUAL-function)
- DV1300C can also be used with regular crimp dies for the 1300C-system no die holders are necessary when using DUAL-dies
- weight 4.9 kg
- dimensions 285 mm x 140 mm

6

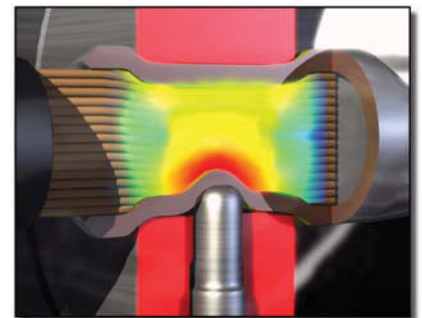
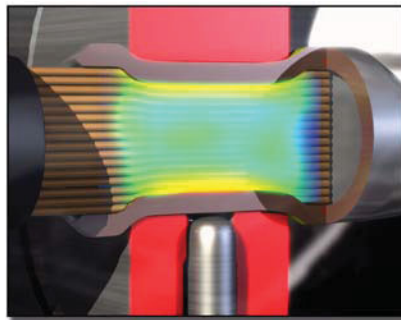
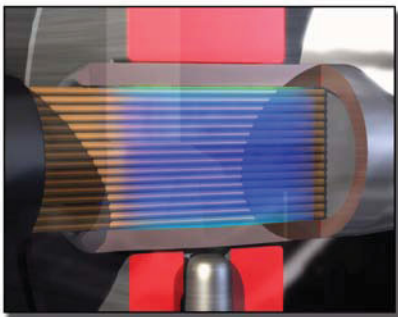



Accessories for crimping flexible Cu-conductors in the DUAL Crimp system DV1300, DV1300C and PVL1300DUAL

DUAL crimp dies

Supplied in pairs.

For crimping of flexible Cu conductors in terminals type KRF or connectors type KSF.

No die holders necessary.



Die pair 13DB20.



Die pair 13DCB20.

mm ²	Dies for DV1300 and PVL1300DUAL	Dies for DV1300C	No. of crimps
10	13DB8	13DCB8	1
16	13DB9	13DCB9	1
25	13DB11	13DCB11	1
35	13DB13	13DCB13	1
50	13DB14,5	13DCB14,5	1
70	13DB17	13DCB17	1
95	13DB20	13DCB20	1
120	13DB22	13DCB22	2
150	13DB25	13DCB25	2
185	13DB27	13DCB27	2
240	13DB30	13DCB30	2
300	13DB32	13DCB32	2



SYSTEM V250 for crimping Cu terminals and connectors 10 - 800 mm², C-sleeves up to 300 mm² and Al terminals and connectors 16 - 630 mm²

V250



Crimp types



V250

Crimp head for crimping of Cu terminals type KRF/KSF, KRT/KST, KR D/KSD 10-800 mm², C-sleeves up to 300 mm², Al terminals and connectors 16-630 mm². Used together with footpump **P4000**, battery / mains powered pump **PS710** and mains powered pump **P1000**.

Particulars:

- equipped with oil spray safety protection cap
- working pressure 63 MPa (630 bar)
- crimp force 250 kN (25 ton)
- tested with Elpress pumps and connectors
- weight 4.6 kg, excl. accessories
- dimensions Ø 111 mm x 280 mm



Accessories for crimping Cu with V250

- Note that KRF terminals may be used on flexible (IEC60228, class 5) as well as stranded (class 2) conductors and that KRD and KRT terminals are used on stranded conductors.

Crimp dies

Supplied in pairs.

For hexagonal crimping of Cu terminals and connectors. If not otherwise indicated, use inner die holder V2506 and outer die holder V2508.



Die holder V2508 + B-dies + die holder V2506.



Die pair B2542.

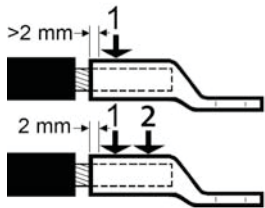

One and two crimps.

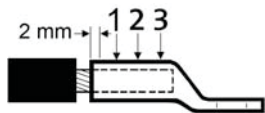

Three crimps.

Cat. no.	Description
V2506	Inner die holder
V2508	Outer die holder

KRF/KSF		
mm ²	Dies for	No. of crimps
10	B8	1
16	B9	1
25	B11	1
35	B13	1
50	B14,5	1
70	B17	1
95	B20	1
120	B22	1
150	B25	1
185	B27	1
240	B30	1
300	B2532*	1
400	B2538*	2
500	B2542*	2
630	B2553*	3
800	B2553*	3

* Use without die holders.

KRT/KST		
mm ²	Dies for	No. of crimps
10	B7	1
16	B8,5	1
25	B10	1
35	B12	1
50	B14	1
70	B16	1
95	B18	1
120	B19	1
150	B22	1
185	B24	1
240	B26	1
300	B30	1
400	B32	1
500	B2540*	2
630	B2545*	3
800	B2553*	3

* Use without die holders.



KRD/KSD		
mm ²	KRD/KSD	No. of crimps
10	B8	1
16	B8	1
25	B9	1
35	B11	1
50	B12	1
70	B14	1
95	B16	1
120	B19	1
150	B22	1
185	B25	1
240	B27	1
300	B30	1
400	B2532*	1
500	B2540*	2
630	B2545*	3
800	B2553*	3

* Use without die holders.

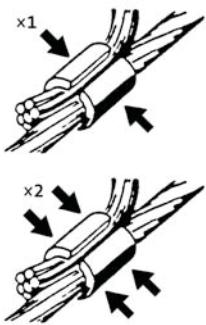

Crimp sequence.

DIN46235		
mm ²	DIN46235 dies	No. of crimps
10	B6DIN	1
16	B8DIN	1
25	B10DIN	1
35	B12DIN	1
50	B14DIN	1
70	B16DIN	1
95	B18DIN	1
120	B20DIN	1
150	B22DIN	1
185	B25DIN	2
240	B28DIN	2
300	B32DIN	3



Die holder V2508 + BC-dies + die holder V2506.

For oval crimping of Cu branch connectors (C sleeves). If not otherwise indicated, use inner die holder V2506 and outer die holder V2508.

Main conductor mm ²	Branch mm ²	Dies	No. of crimps
10-6	10-6	BC4*	1
16-10	16-6	BC5	1
25-16	25-16	BC6	1
50-16	50-16	BC8-9	1
70-50	70-25	BC11	1
95-70	95-25	BC13	1
120-95	120-25	BC15	1
150-120	150-35	B25C16**	1
185-150	185-35	B25C18**	2
300-240	300-35	B25C21**	2

* Die nest must be marked C4A to connect 6 mm² main to 6 mm² branch. ** Use without die holders.



LV250



Storage box LV250

Carry box which takes the tool V250 and all necessary accessories to crimp Elpress Cu terminals and through connectors.

Particulars:

- steel reinforced plywood
- polyethylen insert material
- the box can be used as storage or be taken to site
- sturdy, form cut inserts
- weight 5.2 kg, excl. accessories
- length 570 mm, width 467 mm, height 130 mm.



Accessories for crimping Al with V250

- When indent crimping Al terminals and connectors, two indents are always made, see picture.

Crimping, Punch and Matrix

For indent crimping of Al terminals and connectors.
(no punch holder is needed)



Matrix holder V2521 + matrix P13M + punch P13D.

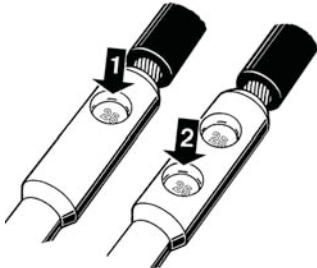

Crimp sequence.

Stranded mm ²	Solid mm ²	Matrix	Matrix holder	Punch
16	16 (+25)	P13M	V2521	P13D
25	35	P13M	V2521	P13D
35	50	P20M	V2521	P20D
50	70	P20M	V2521	P20D
70	95	P20M	V2521	P20D
95	120	P25M	V2521	P25D
120	150	P25M	V2521	P25D
150	185	P25M	V2521	P25D
185	240	P32M	V2531	P32D
240		P32M	V2531	P32D
300	300	P36M	V2531	P36-40-44D
400		P40M	V2531	P36-40-44D
500*		P44M	V2531	P36-40-44D
500**		P2552M		P2552D
630		P2552M		P2552D

* Use with terminals and connectors type AK/AS/AKK/AKS 500B

** Use with terminals and connectors type AK/AS/AKK/AKS 500A

6

Preforming/rounding, Punch and Matrix

For prerounding of sector shaped Al conductors, use punch holder V2540.

Cat. no.	Description
V2540	Punch holder



Matrix holder V2531 + matrix R18MR + punch R18DR + punch holder V2540.

Stranded mm ²	Solid mm ²	Matrix	Matrix holder	Punch
16	16 (+25)	R6MR	V2521	R6DR
25	35	R7MR	V2521	R7DR
35	50	R8MR	V2521	R8DR
50	70	R9MR	V2521	R9DR
70	95	R12MR	V2521	R12DR
95	120	R13MR	V2521	R13DR
120	150	R15MR	V2521	R15DR
150	185	R16MR	V2521	R16DR
185	240	R18MR	V2531	R18DR
240		R20MR	V2531	R20DR
300	300	R21MR	V2531	R21DR
400		R26MR	V2531	R26DR
500		R28MR	V2531	R28DR



L-Alu



Storage box L-Alu

Complementary carry box to LV1300B and LV250 which takes all necessary accessories to crimp Elpress Al terminals and through connectors.

Particulars:

- steel reinforced plywood
- polyethylen insert material
- the box can be used as storage or be taken to site
- sturdy, form cut inserts
- weight 5.2 kg, excl. accessories
- length 570 mm, width 467 mm, height 130 mm.



Accessories for crimping overhead line connectors with V250



Die holder V2508 + BNP-dies + die holder V2506.

Crimp dies

Supplied in pairs.

For hexagonal crimping of overhead line connectors for conductors **type AlMgSi**.

mm ²	Die holder	Die holder	Dies	No. of crimps
31-62	V2506	V2508	B16NP	2 x 5
99	V2506	V2508	B20NP	2 x 5
157	V2506	V2508	B26NP	2 x 8
241	V2506	V2508	B32NP	2 x 8

Supplied in pairs.

For hexagonal crimping of overhead line connectors for conductors **type ACSR (FeAl)**.

mm ²	Die holder	Die holder	Dies for steel sleeve	Dies for Al-sleeve	No. of crimps
62	V2506	V2508	B6FE	B16NP	2 x 5
99	V2506	V2508	B8FE	B20NP	2 x 5



Crimp station for industrial crimping needs, for crimping flexible conductors in KRF/KSF-terminals 10 - 300 mm²

CS2500

Crimp station CS2500 offers effective production with highest operator safety. Advanced intelligent features combined with simplicity make the product unique.



Crimp station CS2500.



Analyzer, crimp station CS2500 and pump PS710D.



Dies 13DCB20.

Particulars:

- designed for continuous production of Cu tube terminals, 10 - 300 mm²
- fast low force locking and unlocking of terminals, reduces the total crimp cycle significantly
- constructed to give high personal safety
- high crimping force up to 250 kN, self-adjusting for optimal durability of tool and accessories
- one crimp cycle regardless crimp size
- Elpress patented DUAL System is used
- Elpress hydraulic pump unit, of type PS710 with foot pedal and with advanced control and supervision is attached
- CE-approved, fulfilling machine safety regulations
- PC-software for crimp analysis is available
- to be used with mains powered pump PS710D
- PS710D flexible power source 100 to 240VAC 50-60Hz secures no mains power restrictions
- weight, pump unit 12.3 kg
- dimensions, pump unit 390 x 225 x 225 mm
- weight, mains unit 8.6 kg
- dimensions, mains unit 390 x 225 x 140 mm
- weight, crimp unit 59.5 kg
- dimensions, crimp unit 200 x 350 x 340 mm

Dies

Supplied in pairs, incorporating Elpress DUAL system. For crimping of Cu terminals and connectors, KRF/KSF. Used without die holders.

mm ²	Dies	No. of crimps
10	13DCB8	1
16	13DCB9	1
25	13DCB11	1
35	13DCB13	1
50	13DCB14,5	1
70	13DCB17	1
95	13DCB20	1
120	20DCB22	1
150	20DCB25	1
185	20DCB27	1
240	20DCB30	1
300	20DCB32	1



Analyzer, software for analysis of crimps and system calibration

The Analyzer computer software is used for quality assurance of crimping work. In a simple way all crimps can be examined in a PC. This unique SPC-tool, Statistic Process Control, give the opportunity to look upon crimping as a measurable process. By definition, process control is a statistical program for systematic studies of variations in operational performance. Import and export of information to customers or just internal can now be realized, as well as printing reports.

Particulars:

- Elpress Analyzer improves total quality
- helps the operator
- provides a tool for process improvement
- monitors and measure all crimps
- supports preventive maintenance of equipment
- creates traceability and documents
- makes communication easy
- increases user competence
- eliminates defective crimps
- delivered with instructions for use

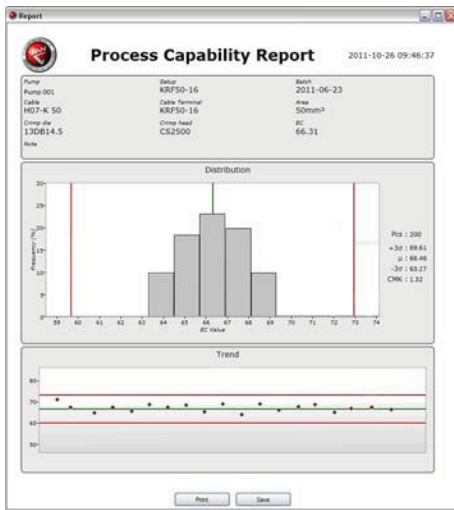

Analyzer, monitors and measure all crimps.



The Analyzer computer software is used for quality assurance of crimping work.



Tool for Cu terminals and connectors 500 - 1000 mm², C-sleeves 185 - 300 mm² and Al terminals and connectors 800 - 1200 mm²

V1470

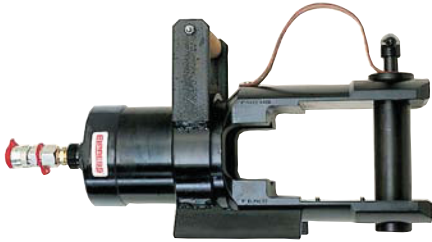

Crimp types



V1470

Elpress crimp head, used together with foot pump P4000 or battery / mains powered electro hydraulic pump PS710.

Particulars:

- equipped with oil spray safety protection cap
- working pressure 63 MPa (630 bar)
- crimp force 400 kN
- supplied in a solid plywood box
- weight 21.5 kg (incl box 28.5 kg)
- length 510 mm, width 235 mm



Accessories for crimping Cu and Al with V1470



B4040 dies.

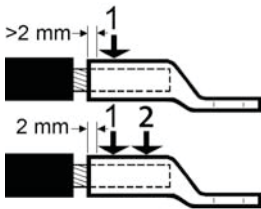

One and two crimps.

- Two crimps/indents are made when crimping Cu terminals 500 - 1000 mm², and Al terminals 800 - 1200 mm².
- For Cu branch connectors only **one crimp** is made.

Crimp dies

Supplied in pairs.

For hexagonal crimping of Cu terminals and connectors.

mm ²	Cable type/Terminal or connector type	Dies	No. of crimps
500	Stranded/KRD/KSD/KRT/KST	B4040	2
500	Flexible/KRF/KSF	B4042	2
630	Stranded/KRD/KSD/KRT/KST	B4045	2
630	Flexible/KRF/KSF	B4053	2
800	Stranded/KRD/KSD/KRT/KST	B4053	2
800	Flexible/KRF/KSF	B4053	2
1000	Stranded/KRD/KSD/KRT/KST	B4056	2

For oval crimping of branch connectors (C sleeves).

Main conductor, mm ²	Branch, mm ²	Dies	No. of crimps
185-150	185-35	B40C18	1
300-240	300-35	B40C21	1



B40C18 dies.

Punch and Matrix

For indent crimping of Al terminals and connectors.

Stranded, mm ²	Matrix holder	Matrix	Punch
800	V1471	W60M	W60D
1000	V1471	W60M	W60D
1200	V1471	W70M	W70D

Always make two crimps on Al.



Crimp sequence.



Matrix holder V1471 + matrix W60M + punch W60D.



Hydraulic foot pump

P4000



P4000

Elpress hydraulic footpump.

Particulars:

- unique design in high tensile aluminium alloy
- standard setting 630 bar (max setting to 700 bar)
- safety valve for relief at all pressures
- a pressure gauge can be attached to indicate working pressure
- ergonomic design
- high finish anodised surface - easy to keep clean
- high efficiency two-step oil flow
- simple foot operated off-loading (piston return) after automatic stop at full pressure
- robust and stable to work with
- practical storage position for hose
- supplied in steel reinforced plywood storage and carrying box
- low weight, 8.6 kg, incl. 2.2 m hose
- dimensions (hose not included) 560 x 180 x 205 mm



Mains powered pump for industrial use

The pump operates all Elpress crimp heads.

P1000

P1000 is a secure, lean produced 2-step pump as an economical alternative for industrial use where simplicity and reliability is required. The pump is supplied with Elpress safety hose with quick coupling. The robust although light weight-ed design allows intensive use in most cases. The pump is CE-approved.

P1000



Particulars:

- function Self holding pressure during crimp cycle, automatic return after completed crimp
- hydraulic pressure: Working range 0-63 (70) MPa, adjustable
- hydraulic flow: Low pressure (up to 1.5 MPa) approx. 0.8 l/min, High pressure (more than 1,5 MPa) 0.2 l/min
- oil volume 2 l (usable 1,8 l)
- oil hydraulic oil ISOVG32
- mains connection 230 V AC 50/60 Hz
- allowable voltage fluctuation: Rated voltage $\pm 5\%$
- electric motor 0.25 kW, Class E insulation, open type commutated motor 230 V, 50/60 Hz single-phase, Max. current: 2.8 A (5 min.)
- protection class IP20
- environment temperatures 0 - 40°C
- CE-approved: Machine safety 98/37/CE, LVD 73/23/EEC
- hydraulic hose 2.4 m, quick coupling, manoeuvre handle 12 V AC
- mains cord 1.5 m earth plug
- weight 15 kg (incl. hose)
- measures, w x d x h approx. 250 x 150 x 384 mm (excl. hose)



Light weight and handy pump designed according to customer request

PS710

PS710 is a hydraulic battery / mains powered pump for crimping with advanced control and supervision of the crimp procedure. It is equipped with a flexible system for almost all crimp applications where high performance and reliability is required. The pump is suitable for cable harness manufacturing as well as for electricians working with utility, installation or service work. PS710 has power source for every kind of crimping work.



Technical data:

- possible to use different working pressures, 0 to 700 Bar.
- PC software, Analyzer, for crimp analysis and quality process integration
- can be used with a PC in a data network with a printer
- oil flow at 20 bar: 0.6 litre/min (PS710D 1.2 litre/min)
- oil volume: 1.0 litre
- oil type: HYDREX MV 22 (hydraulic oil, mineral type) or similar
- mains power 100-240 VAC 50-60 Hz
- Li-ion battery 28.8 V, 3.0 Ah
- crimps/battery charge: 120 crimps with Cu 150 mm²
- charger 230 VAC 50 Hz, 10.8-28.8 V, charging time 65 min
- protection class IP54
- ambient temperature - 15 to 40 °C
- CE-approved: Machine safety 98/37/EG, Electro magnetic compatibility 2004/108/EG, Low voltage directive 73/23/EEG, ROHS 2002/95/EC, WEEE 2002/96/EC
- weight approx. 11 kg
- small dimensions 370x250x160 mm

The pump system consists of three basic versions, all with customizing possibilities;

PS710D

For the cable harness manufacturer.



Technical data:

- unique electronic system together with a special PC-software
- process control and analysis, SPC – each crimp can be traced
- communication to PC in real-time, immediate quality check
- integrated communication through CAN with Elpress CS2500 unit
- high flow hydraulic pump for fastest crimping movement
- can be used with a PC in a data-network with a printer
- to be used with crimp station CS2500



PS710E

For the installer working in the distribution network or in the industry.



Technical data:

- small size and low weight make it easy to use in every situation
- highest performance both with Li-ion battery 28.8 V and mains power
- display with keypad for full pump status information to operator
- possibility to have crimps stored in control system
- PC communication with USB
- to be used with crimp head system 1300, 250 or 1470

PS710R

For the user asking for standard solutions (without need of crimp traceability).



Technical data:

- pump control without electronic system, relayed controlled
- easy equipped without data communication
- without battery
- to be used with crimp head system 1300, 250 or 1470

Standard solutions:

PS710E251 *

Included:

- pump E-version
- mains cable (for EU)
- hydraulic hose 2.5 m
- battery
- charger
- strap

PS710E501 *

Included:

- pump E-version
- mains cable (for EU)
- hydraulic hose 5.0 m
- battery
- charger
- strap

PS710R250 *

Included:

- pump R-version
- mains cable (for EU)
- hydraulic hose 2.5 m
- strap

* for customers outside EU-countries, please contact Elpress



Notes



Overhead line connectors and tools

Twist connectors for Cu-wires 10 - 35 mm²	2
Twist connectors for Al-wires 31 - 99 mm²	2
Overhead connectors for alloy AlMgSi (Super B) and Al59 conductors 31 - 241 mm²	3
Overhead connectors for ACSR conductors 62 and 99 mm²	3
SYSTEM 600 for overhead line connectors	4
SYSTEM 1300 for overhead line connectors	8
SYSTEM V250 for overhead line connectors	10

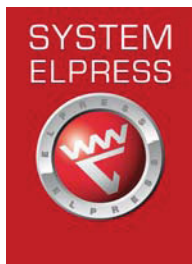

System Elpress

System Elpress consists of connectors and tools tested together for optimum connection result. The System concept makes you as a customer able to feel secure when using our system and to be sure a safe connections is made when Elpress products are used correctly.

Introduction

Elpress connector range for overhead lines includes crimp types for alloy aluminium wires like AlMgSi (Super B) and Al59 wires as well as for certain ACSR conductors. Twist type connectors for both Al and Cu wires are also offered.

Crimp tools types T2600, V600, V611, PVL611, V1300, PVL1300 and V250 may be used.

Twist connectors for Cu-wires 10 - 35 mm²

- material copper
- for single strand and multi-strand wire, see note
- the connector is twisted in the opposite direction to the direction of lay of the wire strands
- twist tool: adjustable spanner

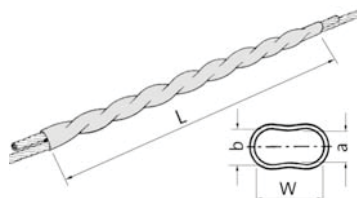

Cat. no. mm ²	mm a	b	W	L	Pcs/ pack	No. of twists made	Marking Elpress logo XX = Year	Note
K10T	3,6	4,0	7,8	200	100	5	K10T XX	1
K16	5,2	5,8	11,1	250	100	3,5	K16 XX	2
K25	6,2	7,0	13,8	300	100	3,5	K25 XX	2
K35	7,5	8,3	16,2	350	100	3,5	K35 XX	2

Note

- 1 Single strand
- 2 Multi strand wire

Twist connectors for Al-wires 31 - 99 mm²

- material aluminium alloy
- the connector is twisted in the opposite direction to the direction of lay of the wire strands
- twist tool: adjustable spanner

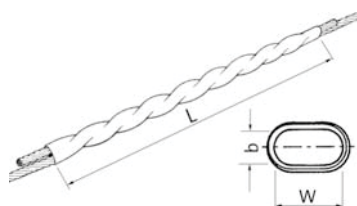

Cat. no.	mm ²	mm b	W	L	Pcs/ pack	No. of twists	Marking Elpress logo XX = Year
1006	31	9,1	17,3	355	100	3,5	1006 XX
1009	49	11,0	21	465	100	4	1009 XX
1010AL	62	12,0	23	480	10	4	1010 XX
1014AL	99	14,7	28	660	10	4,5	1014 XX



Overhead connectors for alloy AlMgSi (Super B) and Al59 conductors 31 - 241 mm²

- material aluminium alloy
- for jointing overhead conductors AlMgSi (Super B) and Al59
- tested according to the requirements of the standard SS 424 1241
- the connector is supplied with inner surface covered with contact paste
- conductor must be cleaned before crimp

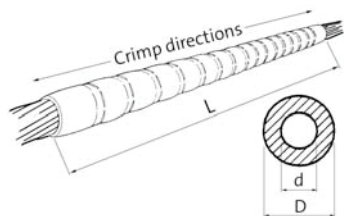

Cat. no. mm ²	mm d	D	L	Pcs/ pack	No. of crimps	Marking Elpress logo XXXX = Year, week	Rec. tool
LFS31	8,0	15,0	200	10	2x5	LFS 31 16 XXXX ALMGSI	V1300, V250
LFS62	11,0	16,0	200	10	2x5	LFS62 16 XXXX ALMGSI	V1300, V250
LFS99	13,5	18,7	250	10	2x5/2x10**	LSF99 20 XXXX ALMGSI	V1300, V250
LFS157	17,5	24	400	5	2x8	LSF157 26 XXXX ALMGSI	V1300, V250
LFS241	21	30	450	5	2x8	LSF241 32 XXXX ALMGSI	V1300, V250

** when crimping with T2600, V600, V611 and PVL611 2 x 10 crimps are necessary

Overhead connectors for ACSR conductors 62 and 99 mm²

- outer Al-alloy connector + inner steel connector for the reinforcement wire
- meets the requirements of SS 424 12 41

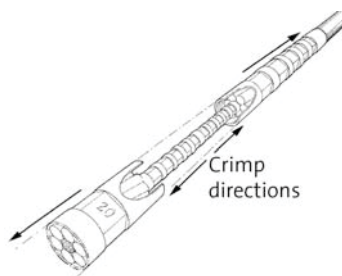

Cat. no. mm ²	mm d	D	L	kg/3	No. of crimps*	Marking Elpress logo XXXX = Year, week	Pcs/ pack	Rec. tool
LFEAL62	11	16	310	0,35	Al: 2x5 Steel: 2x5	LFEAL 62 6 XXXX	3	V1300, V250
LFEAL99	13,5 5	18,7 8	360 95	0,5	Al: 2x5 Steel: 2X5	LFEAL 99 20 XXXX LFEAL 99 8 XXXX	3 3	V1300, V250

*Crimp sequence, see picture

Crimp sequence, LFEAL.



Hydraulic crimp systems for overhead connectors

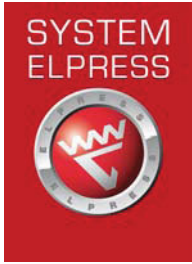

System Elpress

System Elpress consists of connectors and tools tested together for optimum connection result. The System concept makes you as a customer able to feel secure when using our system and to be sure a safe connections is made when Elpress products are used correctly.

Hydraulic crimp systems

Elpress hydraulic crimp systems fit Elpress terminals and connectors from 10 to 1200 mm². The systems comprise either pumps and crimp heads which can be freely combined or by complete hand held tools where these functions are integrated.

For crimping, prerounding of sectorised conductors, cable cutting, etc. there are a variety of accessories. Together with matching terminals the complete crimp system is formed. Both pumps and manual tools have, with a few exceptions, fast feed function that allows the actual crimping to start after the dies have rapidly been brought in contact with the terminal. There is also a full-closure function to safe-guard a complete crimp action.

V1300-system



Cu terminals

V1300 system for crimping of Cu terminals 10-400 mm². The V1300-system is also available in a C-version with an open head for crimping of Cu terminals in narrow spaces.



Al terminals

V1300 system for crimping of Al terminals and prerounding of Al conductors 16-400 mm². Prerounding is done on sector-shaped Al conductors.

V250-system



Cu terminals

V250-system for crimping of Cu terminals 10-800 mm².



Al terminals

V250-system for crimping of Al terminals and prerounding of Al conductors 16-630 mm². Prerounding is done on sector-shaped Al conductors.



Tools for Cu terminals 10 - 240 mm², Al terminals 16 - 25 mm² (-35 solid) mm² and C-sleeves 6 - 50 mm²

T2600/T2600B/T2600C

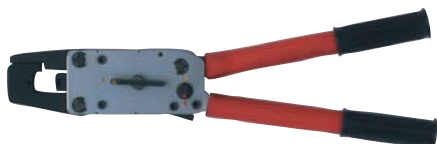

Crimp types



EIPRESS		Hexagon	KSF	KRF	↓
	TB	8	10	1	
		9	16	1	
		11	25	1	
		13	35	1	
		14,5	50	1	
		17	70	2	
	20	95	2		
		C			↓
		C4		1	
		C5		1	
		C6		1	
		C8-9		2	

Information label for crimp tools T2600.

T2600/T2600B/T2600C

Mechanical handtool for crimping of Cu- and Al terminals:
 T2600 for crimping of Cu terminals type KRF/KSF 10-95 mm²
 T2600B for crimping of Cu terminals type KRD/KSD 10-120 mm²
 T2600C for crimping of Cu terminals type KRT/KST 10-120 mm²

Particulars:

- rapid opening enables easy die change and quick removal after jointing
- crimp die (TB7) is available for solid 10 mm² Cu-connector, (for EXCL-type cable or similar)
- crimp force up to 57 kN
- rapid die closure and minimum handle force
- easy to operate in confined spaces
- only four dies are required to crimp 10 - 120 mm² Cu (KRD/KRT)
- rapid feed function
- supplied in a metal box
- equipped with full closure mechanism
- weight 1.9 kg
- length 440 mm, width 140 mm

V600



Crimp types



V600

Crimp head for crimping Cu terminals of type KRF/KSF 10-150 mm², KRD/KSD 10-185 mm², KRT/KST 10-240 mm² and C-sleeves up to 50/50 mm². Used together with footpump P4000, battery / mains powered pump PS710 and mains powered pump P1000.

Particulars:

- crimping force 55 kN
- robust textile bag with room for 10 die pairs
- weight 2.1 kg
- dimensions 189 x 53 x 74 mm



V611



Crimp types



V611

Hydraulic tool for crimping of Cu terminals type KRF/KSF 10-150 mm², KRK/KSD 10-185 mm², KRT/KST 10-240 mm² and C-sleeves up to 50/50 mm². Uses the same dies as T2600, V600 and PVL611.

Particulars:

- two-step, fast feed piston movement to crimp engagement which makes the crimp cycle shorter
- crimp force 60 kN
- supplied in a robust textile bag with foam rubber insert
- weight 2.5 kg
- dimensions 425 x 115 x 53 mm

PVL611

PVL611DB, supplied with 2 batteries

PVL611-US, supplied with 115 VAC charger

Battery crimp tool for crimping of Cu terminals type KRF/KSF 10-150 mm², KRK/KSD 10-185 mm² and KRT/KST 10-240 mm² and C-sleeves up to 50/50 mm². Uses the same dies as T2600, V600 and V611.

Particulars:

- flexible and ergonomic design
- buzzing signal and flashing light if right pressure is not achieved
- LED lightning for work in dark environments
- possibility to document each crimp for unique service control
- crimp force 55 kN (6 ton)
- crimps/charge: 100-200 depending on size and temperature
- crimp time: 3-6 s depending on size
- working temperature -20°C to +40°C
- environmental friendly battery, Li-Ion Makita, 1.3 Ah, 18V
- 230 VAC battery charger Li-Ion Makita, charging time 15 min
- LED indication of charge status
- for service and installation use
- supplied with robust plastic case, battery, charger and instruction manual
- weight 2.5 kg, (incl battery)
- dimensions 387 x 116 x 75 mm

PVL611



Crimp types





Accessories for crimping overhead line connectors with T2600, V600, V611 and PVL611



TBNP dies.

For overhead line connectors for alloy Al conductors, hexagonal crimping.

mm ²	Dies	No. of crimps
31-99	TBNP16-20	Die side 16: 2x5 Die side 20: 2x10



SYSTEM 1300 for Cu terminals and connectors 10 - 400 mm², C-sleeves 6 - 120 mm² and Al terminals and connectors 16 - 400 mm²

V1300



Crimp types



V1300

Crimp head for crimping of Cu terminals type KRF/KSF 10-400 mm², KRD/KSD 10-400 mm², KRT/KST 10-400 mm², C-sleeves up to 120 mm², Al terminals and connectors 16-240 mm². Used with footpump P4000, battery / mains powered pump PS710 or mains powered pump P1000.

Particulars:

- equipped with oil spray safety protection cap
- light and flexible steel crimp head
- special nitrogen anti-corrosion surface treatment
- working pressure 63 MPa (630 bar)
- crimp force 130 kN (13 tons)
- weight 3.7 kg, excl. accessories
- length 270 mm, incl. quick coupling, width 82 mm

V1311

V1311



Crimp types



Hydraulic handtool for crimping of Cu terminals type KRF/KSF 10-400 mm², KRD/KSD 10-400 mm², KRT/KST 10-400 mm², C-sleeves up to 120 mm², Al-terminals and connectors 16-240 mm². Uses the same accessories as for V1300 above.

Particulars:

- automatic fast forward action
- requires low hand force, about 245 N at max. force
- crimp force 130 kN (13 tons)
- weight 4.9 kg, excl. accessories, length 590 mm

PVL1300

PVL1300



Crimp types



PVL1300DB, supplied with 2 batteries

PVL1300-US, supplied with 115 VAC charger

Battery powered crimp tool for crimping of Cu terminals type KRF/KSF 10-400 mm², KRD/KSD 10-400 mm², KRT/KST 10-400 mm², C-sleeves up to 120 mm², Al terminals and connectors 16-240 mm². Uses the same crimp accessories as the other products in the above V1300 System.

Particulars:

- ergonomic design that optimizes the balance of the tool in the users hand
- buzzing signal and flashing light if right pressure is not achieved
- LED lightning for work in dark environments
- possibility to document each crimp for unique service control
- for service and installation use
- crimp force 124 kN (13 ton)
- crimps/charge: 60-120 depending on size and temperature
- crimp time: 4-12 s depending on size
- working temperature -20°C to +40°C
- environmental friendly battery, Li-Ion Makita, 3.0 Ah, 18V
- 230VAC battery charger Li-Ion Makita, charging time 22 min
- LED indication of charge status
- supplied with robust plastic case, battery, charger and instruction
- weight 5.4 kg, (incl battery), dimensions 412 x 319 x 75 mm



Accessories for crimping overhead line connectors with V1300, V1311 and PVL1300

Crimp dies

Supplied as a pair.

For hexagonal crimping of connectors for overhead conductors of AlMgSi (Super B) and Al 59.



mm ²	Inner die holder	Outer die holder	Dies	No. of crimps
31-62	V1316	V1318	B16NP	2x5
99	V1316	V1318	B20NP	2x5
157			13B26*	2x16
241			13B32*	2x16

* Used without die holders.

Supplied as a pair.

For hexagonal crimping of connectors for overhead ACSR conductors.

Die holders V1316 and V1318 to be used.

mm ²	Steel connector (inner)		Al-connector (outer)	
	Dies	No. of crimps	Dies	No. of crimps
62	B6FE	2x5	B16NP	2x5
99	B8FE	2x5	B20NP	2x5

V1318 outer die holder + BNP type dies + V1316 inner die holder.



SYSTEM V250 for crimping Cu terminals and connectors 10 - 800 mm², C-sleeves up to 300 mm² and Al terminals and connectors 16 - 630 mm²

V250



Crimp types



V250

Crimp head for crimping of Cu terminals type KRF/KSF, KRT/KST, KR D/KSD 10-800 mm², C-sleeves up to 300 mm², Al terminals and connectors 16-630 mm². Used together with footpump **P4000**, battery / mains powered pump **PS710** and mains powered pump **P1000**.

Particulars:

- equipped with oil spray safety protection cap
- working pressure 63 MPa (630 bar)
- crimp force 250 kN (25 ton)
- tested with Elpress pumps and connectors
- weight 4.6 kg, excl. accessories
- dimensions Ø 111 mm x 280 mm



Accessories for crimping overhead line connectors with V250

Crimp dies

Supplied in pairs.

For hexagonal crimping of overhead line connectors for conductors **type AlMgSi**.



mm ²	Die holder	Die holder	Dies	No. of crimps
31-62	V2506	V2508	B16NP	2 x 5
99	V2506	V2508	B20NP	2 x 5
157	V2506	V2508	B26NP	2 x 8
241	V2506	V2508	B32NP	2 x 8

Supplied in pairs.

For hexagonal crimping of overhead line connectors for conductors **type ACSR (FeAl)**.

mm ²	Die holder	Die holder	Dies for steel sleeve	Dies for Al-sleeve	No. of crimps
62	V2506	V2508	B6FE	B16NP	2 x 5
99	V2506	V2508	B8FE	B20NP	2 x 5

Die holder V2508 + BNP-dies + die holder V2506.



Notes



Screw connectors

General information	2
Screw connectors and terminals	3
Through connectors 10 - 630 mm²	4
Screw terminals 10 - 630 mm²	4
ISL2201, holding tool	4



Screw connectors for low and medium voltage

Elpress screw terminals and connectors are used at low and medium voltages and for

- stranded and solid Al and Cu conductors
- round cross sections 10 mm² up to 630 mm²
- sector cross sections 16 mm² up to 240 mm²
- up to 36 kV
- supplied in sealed plastic bag with detailed instructions for use

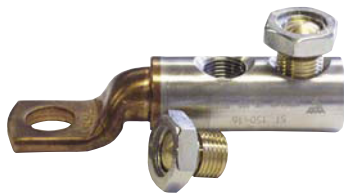

Screw terminal.



Screw through connector.

Connection to the conductors is achieved by tightening the screws in the through connector or terminal to a pre-determined torque. Through connectors and terminals are made of aluminium. The terminal palm is made of copper and the accompanying screws Elpress uses are made of brass to reduce friction and facilitate installation.

Tools for assembly can be a spanner/wrench or a battery-operated impact wrench which has a high torque force, > 100 Nm. To facilitate installation there is holding tool, ISL2201, to hold the screw connector in its right position during tightening of the screws. The screw connectors have a partition wall to enable jointing of oil-filled conductors to plastic-insulated XLPE conductors. The screw connectors meet the requirements of IEC 61238-1.

Handles multiple cross section areas

The installation of a screw connector can be done easily without heavy special tools and can withstand several area stages in the same connector, for instance 10-50 mm². The user gets a reduced range of products and a flexible solution.

Washer solution

To reduce the number of variants of the terminals, washers are delivered with the terminals. A washer is always required for connection of the terminal palm to a bus bar with a screw.



Bolts are tightened using a wrench. It is also possible to use a battery operated wrench.

SC50R50S

On connector SC50R50S the screws are pre-mounted in the connector and covers all areas from 10-50 mm². SC50R50S is also suitable as screen connector for 10-35 mm² Cu/Al.



On connector SC50R50S the screws are pre-mounted in the connector.

Marking

Elpress marking of screw connections shows logo, product name, conductor area (for stranded and solid conductors) and assembly order of the screws. The terminal palm is marked with bolt size (M-thread) for bolt connections.

Cat. no. SL70R70S-10-12

SL = Screw terminal

70R = max 70 mm² round conductors

70S = max 70 mm² sector conductors

10-12 = screw size 10 and 12 (M-thread)

Cat. no. SC150R95S

SC = screw through connector

150R = max 150 mm² round conductor

95S = max 95 mm² sector conductor

Screws connection to bus bars

The following apply to bright galvanized nuts and screws in strength class 8.8 used for connecting terminals to Cu and Al bus bars:

- Always use a torque wrench to ensure that they are tightened to the right torque. Ensure it is regularly calibrated in accordance with the supplier's instructions.
- Use the recommended torque in accordance with the screw manufacturer's instructions.
- Always use a hard flat washer to reduce friction between the installation surface and hole edge pressure, min hardness HB200.
- A spring washer in accordance with DIN 6796 may be used together with a flat washer to further increase strength in advanced applications.
- Assemble as shown in image.

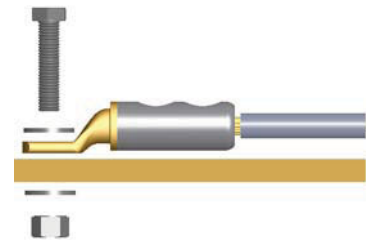

Screw	Tightening torque (Nm)
M5	5
M6	9
M8	21
M10	41
M12	70
M14	110
M16	170
M20	340



Screw connectors and terminals

By means the enclosed special washers for Elpress screw terminals, two bolt dimensions may be used in one palm hole size, see picture and table below. The required stocking of different terminals for different bolts is hereby heavily reduced.

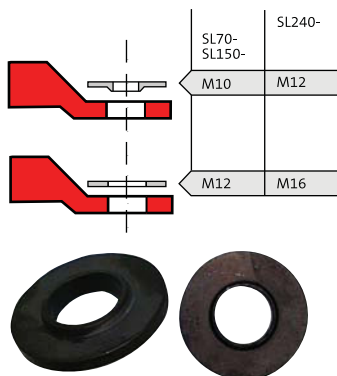

Special washers for Elpress screw terminals.

Stranded and solid conductors area, mm ²	Type	Connector Cat.no.	Terminal M12, M10	Terminal M16, M12
10	round	SC50R50S	SL70R70S-10-12	
16	round sector	SC50R50S SC50R50S	SL70R70S-10-12	
25	round sector	SC50R50S SC50R50S	SL70R70S-10-12 SL70R70S-10-12	
35	round sector	SC50R50S SC50R50S	SL70R70S-10-12 SL70R70S-10-12	
50	round round sector sector	SC50R50S SC95R95S SC50R50S SC95R95S	SL70R70S-10-12 SL70R70S-10-12	
70	round sector sector	SC95R95S SC95R95S SC150	SL70R70S-10-12 SL70R70S-10-12	
95	round round sector sector sector sector	SC150R95S SC95R95S SC150R95S SC95R95S SC150	SL150R95S-10-12 SL150R95S-10-12	
120	round sector sector sector	SC150R95S SC240R185S SC150 SC240	SL150R95S-10-12	SL240R185S-12-16
150	round sector sector sector	SC150R95S SC240R185S SC150 SC240	SL150R95S-10-12	SL240R185S-12-16
185	round sector sector	SC240R185S SC240R185S SC240		SL240R185S-12-16 SL240R185S-12-16
240	round sector sector	SC240R185S SC400R240S SC240		SL240R185S-12-16 SL240R240S*
300	round	SC400R240S ¹⁾		SL400R240S ¹⁾
400	round	SC400R240S ¹⁾		SL400R240S ¹⁾
500	round	SC630R		SL630R*
630	round	SC630R		SL630R*

* Palm hole as requested

1) for un-compressed cable. For compressed cable, contact Elpress.



Through connectors 10 - 630 mm²

- Screw material: brass, for lowest friction
- Partition to prevent fluid passing through
- Voltage up to 36 kV
- Meets the requirements of IEC-EN 61238-1:2003

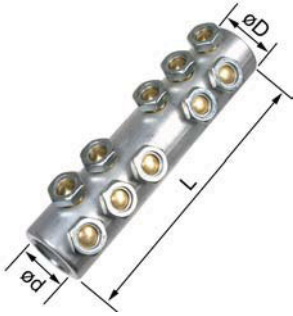

Area	Cat. no.	mm L	øD	ød
10-50	SC50R50S	62	20/17,3*	10,7
50-95	SC95R95S	114	27	16
70-150	SC150	134	33,5	20
95-150	SC150R95S	114	27	16
120-240	SC240	144	38/33*	25
120-240	SC240R185S	134	33,5	20
240-400	SC400R240S	175	41,5	25,7
500-630	SC630R	210	49	33

Suitable for conductors as in table on previous page. * measurement between plane sides

Screw terminals 10 - 630 mm²

- Screw material: brass, for lowest friction
- voltages up to 36 kV
- meets the requirements of IEC-EN 61238-1:2003
- the terminals are of bimetallic type to provide best possible connections to bus bars, apparatus terminals, etc.

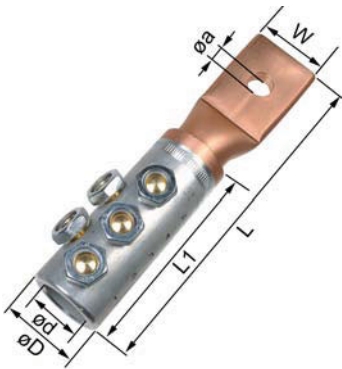

Area	Cat. no.	mm L	W	L1	øD	ød	a
10-70	SL70R70S-10-12	103	25,5	59	21,5	11	11-13
95-150	SL150R95S-10-12	118,5	30,5	70,5	27	16	11-13
120-240	SL240R185S-12-16	133	30	78,5	33,5	20	13-17
240-400	SL400R240S-16	177	37	103	41,5	25,7	17
240-400	SL400R240S-20	177	37	103	41,5	25,7	21
240-400	SL400R240S-00	183,5	37	103	41,5	25,7	*
500-630	SL630R-1	243	55	129	49	33	*

Suitable for conductors as in table on previous page.

*Palm hole as requested

ISL2201, holding tool

To support the terminal or connector while fastening the shear off screws, the ISL2201 has been developed. The tool is produced from high strength material and is easily adjusted for barrel sizes up to 400 mm².

- weight 365 g



Holding tool ISL2201.



Cutting and stripping tools

Introduction	2
Cutting and stripping tool 0.02 - 10 mm² (16 mm²)	3
Stripping tool for cables Ø 2.5 - 40 mm	4
Tools for cutting and stripping of conductors 0.5 - 6 mm² and for cutting up to Ø 20 mm	5
Cutting tools for cables up to Ø 80 mm	7
Tool for stripping of outer conductive layer on MV XLPE cables	10
Battery powered cable cutter	12
Hydraulic cable cutters	13



Cutting and stripping tools for professional use

Stripping tools

Elpress stripping tool EMBLA is a self-adjusting cutting and stripping tool for modern electrical installation. The tool strips a wide range of insulations from PVC to PTFE and takes 0.02-10 mm² with just one tool. The ergonomic design of the tool has result in a lightweight but strong and comfortable tool equally qualified for high volume production and portable/field usage.



EMBLA, ergonomically designed cutting- and stripping tool.



For stripping of larger areas up to Ø40 mm, TOR, a professional stripping tool for cables of all insulation types is used. Designed to fit the hand and for ease of use, TOR can strip the most difficult cables in the harshest of environments.

TOR, stripping tool.

The precise stripping tool ODEN, strips cables Ø2,5-11 mm, is used for stripping of the outer layer for signal cables and the like.



ODEN, precise setting for the different insulations is easily made by means of the nine position setting wheel.

For preparation and stripping of medium voltage conductors, 12-24kV, tools FBS1722 and 1723 are used. FBS1722 strips (Ø10-50 mm) outer conductor screen of XLPE conductors and FBS1723 strips (Ø15-52 mm) PEX insulation on intermediate voltage conductors.



FBS1722, for stripping of outer conductive layer gives a very smooth result.

Cutting tools

Elpress cutting tools are available in several variants for cutting of Cu and Al conductors, up to a diameter of Ø85 mm. Apart from the mechanical cutting tools that cut cables up to Ø20 mm, there is a wide range of hydraulic cutting tools which cuts cables up to Ø85 mm. The electrical cutting tool PKL54 is easy to operate and the protective cap gives high safety for the user. The tool has a preferable scissor action while cutting and cut conductors up to Ø54 mm.



PKL54, cutting tool.



Cutting and stripping tool 0.02 - 10* mm² (16 mm²)

EMBLA

Cutting and stripping tool.

Embla is available in 3 versions:

EMBLA S

- with exchangeable knife cassette, straight blades, for PVC insulations 0.02-10 mm² (AWG 34-8)

EMBLA V

- with exchangeable knife cassette, V-shaped blades, for harder insulations 0.1-4 mm² (AWG 28-12)

EMBLA 16

- with exchangeable knife cassette, curved blades, for PVC insulations 4-16 mm² (AWG 12-6)

AWG	Area	Cat. no.	Weight	Dimensions
34-8	0.02-10 mm ²	EMBLA S	0.136 kg	191x123x20
28-12	0.1-4 mm ²	EMBLA V	0.136 kg	191x123x20
12-6	4-16 mm ²	EMBLA 16	0.136 kg	191x123x20

Particulars:

- **Stripping range**
 - for PVC insulations 0.02-10 mm² (AWG 34-8)
 - for harder insulations 0.1-4 mm² (AWG 28-12)
 - for PVC insulations 4-16 mm² (AWG 12-6)
- **Cutting range**
 - stranded conductors up to 10 mm² (AWG 8)
 - single strand conductors up to 1.5 mm² (AWG 16)
- **Versatility:** The easy exchange of stripping cassettes makes stripping of most insulation materials possible. The working range is the widest available for these type of tools.
- **Precision:** Precise knife adjustment allows stripping of conductors with thin insulations without damage to the strands. When the stripping action is completed, the knives open and are kept so during the retraction of the knives. The scratchfree conductor is thus easy to take out.
- **Ergonomy:** A specially designed movable handle with a soft rubber inlay, low friction, optimised handle opening width, an angled head and low weight safeguard comfortable work with lowest work load.
- **Long life expectancy:** Strip cassettes and knives can be exchanged for very long tool life.
- **Reliability:** Tested to over 150 000 cycles. Produced from a new high tensile plastic with doubled strength compared to ordinary PA6 (nylon).

Accessories

EMBLA can be supplemented with the following spare cassettes for different types and sizes of cable insulations. In one simple operation the cassettes can be replaced.

EMBLA SP S

- with knife, straight blades, for PVC insulations 0.02-10 mm² (AWG 34-8)

EMBLA SP V

- with knife, V-shaped blades, for harder insulations 0.1-4 mm² (AWG 28-12)

EMBLA SP 16

- with knife, curved blades, for 4-16 mm² (AWG 12-6)

AWG	Area	Cat. no.	Weight
34-8	0.02-10 mm ²	EMBLA SP S-cassette	0.020 kg
28-12	0.1-4 mm ²	EMBLA SP V-cassette	0.020 kg
12-6	4-16 mm ²	EMBLA SP 16-cassette	0.020 kg

EMBLA



EMBLA, ergonomically designed cutting- and stripping tool.

EMBLA S-cassette



EMBLA V-cassette



EMBLA 16-cassette



* Note! The cutting capacity of any cutting tool may vary due to conductor design, insulation thickness, hardness of materials etc.



Stripping tool for cables Ø 2.5 - 40 mm

Stripping of cables Ø 4.5 - 40* mm

TOR

Stripping tool for LV cables.

Particulars:

- two exchangeable hooks for covering the wide diameter range
- locked positions for cutting around and along the cable as well as in a spiral
- the cutting can be made on cable outer diameters from 4.5 to 40 mm with insulation thickness up to 4.5 mm (adjustable knife)
- spare blades available and may be stored in an integrated compartment in the handle

TOR



Three stripping functions.

Area	Cat. no.	Weight	Dimensions
Ø 4.5-40 mm	TOR	0.116 kg	150x42x31 mm (small hok) 167x52x31 mm (big hok)
	TOR SP KNIFE (spare blade)	0.010 kg	

Stripping of cables Ø 2.5 - 11* mm

ODEN

Stripping of the outer layer on signal, telephone, instrument, data cables and etc.

Particulars:

- precise setting for the different insulations is easily made by means of the nine position setting wheel
- stripping: cables Ø 2.5 to 11 mm with up to 1.0 mm thick insulations
- strips the outer insulation on most multi conductor and optical cables up to Ø 11 mm
- spare blades available

ODEN

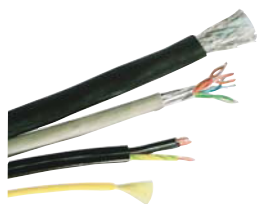

ODEN, for stripping of outer layer on signal, telephone, instrument, data cables and etc.

Area	Cat. no.	Weight	Dimensions
Ø 2.5-11 mm	ODEN	0.028 kg	91x40x19 mm
	ODEN SP KNIFE (spare blade)	0.010 kg	

* Note! The cutting capacity of any cutting tool may vary due to conductor design, insulation thickness, hardness of materials etc.



Tools for cutting and stripping of conductors 0.5 - 6 mm² and for cutting up to Ø 20 mm

Cutting and stripping 0.5 - 6* mm²

SCT001

Cutting and stripping tool.

SCT001



Particulars:

- made from high quality steel
- cuts and strips 0.5 to 6 mm² (20 - 10 AWG)
- lockable strip setting
- light and versatile

Area	Cat. no.	Weight	Dimensions
0.5-6 mm ²	SCT001	0.10 kg	140x65 mm

Cable cutting up to approximately Ø 20* mm

CT10

Cable cutter.

CT10



Particulars:

- cuts Cu and Al cables up to outer Ø 10 mm
- not designed to cut steel
- small and handy
- hardened cutter edges of forged steel
- the special cutter edge designs gives a clean cut surface with low distortion

Area	Cat. no.	Weight	Length
Ø 10 mm	CT10	0.17 kg	165 mm

CT20

Cable cutter.

CT20



Particulars:

- cuts Cu and Al cables up to outer Ø 20 mm
- not designed to cut steel
- relatively small and handy
- hardened cutter edges of forged steel
- the special cutter edge designs gives a clean cut surface with low distortion

Area	Cat. no.	Weight	Length
Ø 20 mm	CT20	0.44 kg	240 mm

* Note! The cutting capacity of any cutting tool may vary due to conductor design, insulation thickness, hardness of materials etc.



Cable cutting up to \varnothing 15* mm

UP-B41

UP-B41



Cable cutter.

Particulars:

- cuts flexible Cu and Al conductors up to 95 mm²
- cuts Cu cables up to approx. \varnothing 15 mm
- not designed for cutting steel
- small and very effective
- a professional tool with very high quality
- gives a clean cut surface

Area	Cat. no.	Weight	Length
\varnothing 15 mm	UP-B41	0.28 kg	200 mm

* Note! The cutting capacity of any cutting tool may vary due to conductor design, insulation thickness, hardness of materials etc.



Cutting tools for cables up to Ø 80 mm

- Not for steel wires or steel wire armoured cables.

Cable cutting up to Ø 34* mm

HKS34

Cable cutter.

Particulars:

- cuts normal types of Cu and Al cables up to Ø 34 mm
- cuts Al-alloyed AC overhead line conductors up to 241 mm² (not ACSR)
- supplied in a robust textile carry bag

HKS34



Area	Cat. no.	Weight	Length
Ø 34 mm	HKS34	0.92 kg	250 mm

Cable cutting up to Ø 50* mm

HKS50

Cutting tool for Cu/Al and steel cable with exchangeable cutting blades. HKS50 is delivered with universal blade UFE1 for Al/Cu, ACSR, Flexibel steel wire and anchoring cable. Supplied in a robust textile bag with instructions for use and a cleaning comb.

Particulars:

- One hand operation
- Scissor movement
- Change blades fast and easy with release of two screws
- Clear marking of usage on the blades
- Reliable and well proven ratchet drive

HKS50



Area	Cat. no.	Weight	Length
Ø50 mm	HKS50	1.4 kg	230 mm

Blades for HKS50



UFE2

UFE1



UFE2

UFE



UCUAL

Area	Cat. no.	Application
Ø 50 mm	UFE2	For Cu/Al, flex. steel wire, INOX, ACSR, screws, anchoring cable, piano wires and catenary cable.
Ø 50 mm	UFE1	For Cu/Al, flex. steel wire, INOX, ACSR, screws, anchoring cable and catenary cable.
Ø 30 mm	UFE2	For Cu/Al, flex. steel wire, ACSR and main application are for cutting data/signal cable.
Ø 50 mm	UFE	For Cu/Al, flex. steel wire, ACSR.
Ø 50 mm	UCUAL	For Cu/Al cable, clean cut and appropriate for most flexible cables. Does not cut steel.

* Note! The cutting capacity of any cutting tool may vary due to conductor design, insulation thickness, hardness of materials etc.



Cable cutting up to Ø 62* mm

HKS62

Cable cutter.

Particulars:

- cuts normal types of Cu and Al cables up to Ø 62mm
- cuts Al-alloyed AC overhead line conductors up to 241 mm² (not ACSR)
- supplied in a robust textile carry bag

HKS62



Area	Cat. no.	Weight	Length
Ø 62 mm	HKS62	1.9 kg	340 mm

Cable cutting up to Ø 80* mm

HKS80

Cable cutter.

Particulars:

- cuts normal types of Cu and Al cables up to Ø 80 mm
- supplied in a robust textile carry bag

HKS80



Area	Cat. no.	Weight	Length
Ø 80 mm	HKS80	3.4 kg	600 mm

Cable cutting up to Ø 35* mm

HKS35F

Front end cable cutter.

Particulars:

- front end "scissors" cutting - easy access to confined areas
- cuts normal types of Cu and Al cables up to Ø 35 mm
- low handle forces needed
- supplied in a robust textile carry bag

HKS35F



Area	Cat. no.	Weight	Length
Ø 35 mm	HKS35F	1.9 kg	330 mm

* Note! The cutting capacity of any cutting tool may vary due to conductor design, insulation thickness, hardness of materials etc.



Cable cutting up to Ø 60* mm

HKS60F

Front end cable cutter.

HKS60F



Particulars:

- front end "scissors" cutting - easy access to confined areas
- cuts normal types of Cu and Al cables up to Ø 60 mm
- low handle forces needed
- supplied in a robust textile carry bag

Area	Cat. no.	Weight	Length
Ø 60 mm	HKS60F	3.8 kg	485 mm

* Note! The cutting capacity of any cutting tool may vary due to conductor design, insulation thickness, hardness of materials etc.



Tool for stripping of outer conductive layer on MV XLPE cables

FBS1722

Stripping tool for outer vulcanised, conductive layer on MV XLPE cables.

FBS1722

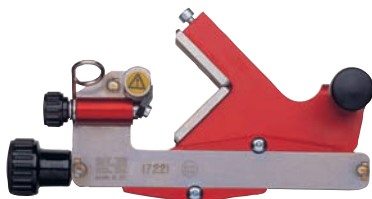

FBS1722 is delivered in a plastic carry box with silicon paste and instructions for use.

Particulars:

- FBS 1722 includes the actual tool, 100 g silicone paste and an instruction, all in a quality plastic carry box
- stripping can be made from \varnothing 10 mm up to \varnothing 50 mm, approximately corresponding to maximum sizes 800 mm² at 12kV, 630 mm² at 24 kV and 500 mm² at 36 kV
- cutting depth is easily set between 0 and 1.2 mm in steps of 0.1 mm
- stripping can be made down to 25 mm from the shield edge and the XLPE surface produced is very smooth all the way
- the HRC 55 hardness cutting blade is specially ground to specific shape and easy to replace when needed

Area	Cat. no.	Weight	Dimensions
\varnothing 10-50 mm	FBS1722	0.80 kg	235x200x55 mm
	FBS1722RS (spare blade)	-	
	FBS1722SP (siliconpaste)	0.10 kg	

* Note! The cutting capacity of any cutting tool may vary due to conductor design, insulation thickness, hardness of materials etc.



Tool for stripping of outer conductive layer on MV XLPE cables

FBS1723

FBS1723

Stripping tool for outer vulcanised, conductive layer on MV XLPE cables.

Particulars:

- FBS1723 includes the actual tool, 100 g silicone paste and an instruction, all in a quality plastic carry box
- the tool is easy to use - the tool rotates with the handle.
- stripping can be made from \varnothing 15 mm up to \varnothing 52 mm, approximately corresponding to maximum sizes 50-1000 mm² at 12kV, 25-1000 mm² at 24 kV, 630 mm² at 36 kV and 500 mm² at 52 kV
- cutting depth is easily set between 0 and 15 mm
- unlimited stripping length
- adjustable feed in 5 positions
- blade available as spare part
- the HRC 55 hardness cutting blade is specially ground to specific shape and easy to replace when needed

Area	Cat. no.	Weight	Dimensions
\varnothing 15-52 mm	FBS1723	1.0 kg	275 x 220 x 65 mm
	FBS1723RS (spare blade)		
	FBS1722SP (silicon paste)	0.10 kg	



FBS1723 is delivered in a plastic carry box with silicon paste and instructions for use.

* Note! The cutting capacity of any cutting tool may vary due to conductor design, insulation thickness, hardness of materials etc.



Battery powered cable cutter

PKL54

Electric cable cutter for copper and aluminium cable; easy and safe to operate.

PKL54



Particulars:

- electric cable cutter for copper and aluminium cable
- not intended for cutting steel
- max cutting diameter 54 mm;
equivalent to 1 kV Cu type FKKJ 4 x 95 mm²
Al type AKKJ 4 x 240 mm²
Al type SE-N1XV 4G x 240 mm²
equivalent to 12 kV Al type AXLJ 3 x 150 mm²
- charger 7.2-24V, charging time for battery approx. 60 min
- the tool has a scissor action when cutting, which produces a good cut
- integrated fuse as overvoltage protection
- protective cap for perfect safety, CE approved
- delivered with case and two batteries, 14.4V NiMh

Accessories:

- PVBP2-Mh, extra battery

Area	Cat. no.	Weight	Dimensions
Ø 54 mm	PKL54	3,5 kg (incl 1 battery)	450x105x120 mm

* Note! The cutting capacity of any cutting tool may vary due to conductor design, insulation thickness, hardness of materials etc.



Hydraulic cable cutters

■ Not for steel wires or steel wire armoured cables.

HKL40/KL40, HKL55/KL55, HKL85/KL85

A range of cable cutters covering virtually all needs for cutting power cables and OH-line wires. The cutting heads are powered by Elpress foot pump P4000, Elpress battery and mains operated electrohydraulic pump PS710 or Elpress mains powered pump P1000.

Area	Cat. no.	Description	Weight	Dimensions
Ø 40 mm	HKL40	Manual cutting tool	5.9 kg	645x85x165
Ø 55 mm	HKL55	Manual cutting tool	3.7 kg	560x55x140
Ø 85 mm	HKL85	Manual cutting tool	7.6 kg	745x72x190
Ø 40 mm	KL40	Cutting head	4.3 kg	285x85x105
Ø 55 mm	KL55	Cutting head	3.0 kg	300x55x110
Ø 85 mm	KL85	Cutting head	6.2 kg	385x75x170

Technical specifications



Hydraulic manual cutters	HKL40	HKL55	HKL85
Hydraulic cutting heads	KL40	KL55	KL85
Max. opening	Ø 40	Ø 55	Ø 85
Max. cutting force, KN	88	43	55
Max. cutting capacity, examples.			
copper cable	Ø 40	400 (500) mm ²	630 mm ²
Cu annealed solid conductor		Ø 20	
Cu rod	Ø 30		
Aluminium cable	Ø 40	3x240+95 mm ²	3x240+95 mm ² 630 (800 mm ²)
Al annealed solid conductor		Ø 25	
ACSR	Ø 40		
Al bar	ca Ø 40		
Telephone cable		Ø 55	
Steel wire (<180 daN/mm ²)	Ø 11		
Steel rod	Ø 18		

Do not cut steel wire armoured cables.

* Note! The cutting capacity of any cutting tool may vary due to conductor design, insulation thickness, hardness of materials etc.



Notes



Deep earthing

Elpress system for deep earthing	2
System design and function	3
Deep earthing system components	4
Power hammer driving studs for Elpress deep earthing system	6
General deep earthing information	7



Elpress system for deep earthing

Advantages

The Elpress deep earthing system has a number of advantages:

- the main earthing wire does not have to be jointed
- the tips and leading rods accept 16 - 95 mm² wire
- can be used for several wire types such as soft or hard copper, galvanised or stainless steel
- when Cu wire is used, the rods act as sacrificial anodes and protects the wire against corrosion
- there is a full control over wire travel during drive down
- earthing resistance can be monitored during drive down
- few parts make earthing easy and reliable
- low total system weight
- very attractive total cost picture



Radio Base Station is an application for Elpress deep earthing system.

Principal design

The Elpress deep earthing concept is a system without extra connection points. The earthing electrode is a copper wire which is pulled down by means of 0.8 m steel tubes ("rods").

A hardened steel tip locks the Cu wire into the leading rod. For each extension rod the wire is pulled a further 0.8 m down alongside the rods. See picture.

As the earthing resistance may be continuously monitored at the other end of the wire, the driving down is interrupted when a satisfactory low resistance is reached. The top extension rod is pulled up and re used.

The driving down is normally made by power hammers with a suitable driving stud or with a sledge hammer and the driving cap FS61 or FS62C.



Driving stud FS62C.

Life expectancy

The Elpress deep earthing system consists of steel tubes and copper wire. The steel tubes, besides their pull-down function, also act as sacrificial anodes with a relatively high corrosion current to the Cu cathode.

This metal combination has a stabilising and neutralising effect on the close by soil. If a lead coated cable exists in the ground a few meters away from the earthing, the corrosion current is approx. 40 % lower than would have been the case without steel tubes. In other words, the lead coating will have life expectancy of almost double.

Experiments have shown that after a few months the corrosion current decreases to practically zero. The explanation is that a specific surface layer, the polarisation layer, is created close to the electrode. The current is reduced and therefore also the corrosion. How great this effect will be is related to among other things the soil properties. An AC load will theoretically reduce the corrosion and in that case the expected life will often be longer.



System design and function

The Elpress System consists of five parts:

- hardened steel tip
- leading rod
- extension rods
- driving studs or sleeves
- earthing wire (supplied by whole salers)

Simple function

- the earthing wire is inserted into and held by the steel tip
- the extension rods have guiding pins to enter into the previous tube end to form a stable extension of the system
- by monitoring the earthing resistance, the driving down may be interrupted at best point

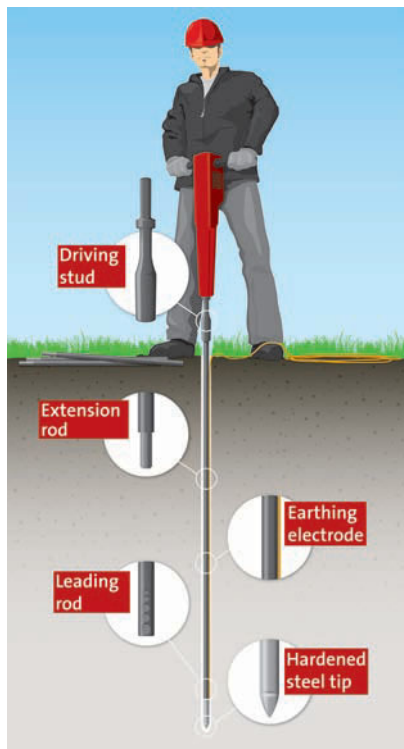

Practical advice

1. Plan the earthing. What soil properties prevail?
Normal or soft soils - FS-rods are enough
Hard and stony soils - FSHD-rods are recommended
Are parallel earth takes of interest?

2. Try to establish the soil resistivity. From this and the maximum earthing resistance, the depth can be estimated.
3. Start the drive down by locking the wire into the steel tip with the leading rod. A 16 mm² wire should be folded before the tip is pushed on. In soft soils the drive down may be made with a sledge hammer but in somewhat harder soils a power hammer is preferred. Note that the driving tip in the power hammer must not rotate during driving.
4. Safeguard that the rods and the wire move with same speed. If not, the following is imminent:
 - more rods than wire is needed. The rods may have turned off into a more horizontal track and the wire is taking a short cut
 - the rods travel down but the wire has stopped. The wire has come loose and may be pulled up or the rods have started folding. Stop driving down.
 - rod and wire stop. The rod has hit a stone or rock. If not moving after 10 sec, stop and change place.

If another earthing has to be made, move away 1.5 times the depth of the nearest earthing.

5. Monitor continuously the resistance during drive down. Parallel earthings may be made. Connect together with Elpress C-sleeves or through connectors.

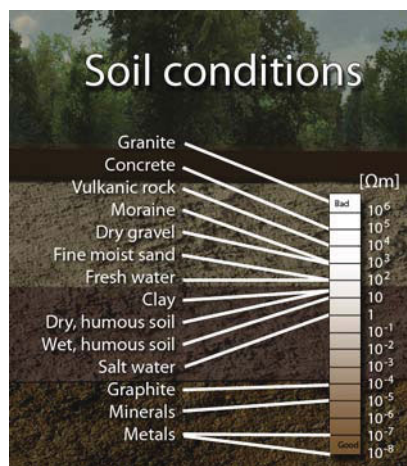

Resistivity in various types of soil.



Measuring of earthing resistance.



The earthing wire locks in the hardened steel tip with the leading rod.



The driving down has started.



Deep earthing system components

FS11



FS11

Steel tip with hardened top.

Particulars:

- special steel material
- accepts different types of earthing wires
- to be used with FS21 leading rod

Area	Cat. no.	Weight	Pcs/pack	Length
16-70 mm ²	FS11	0.90 kg/pack	5	135 mm

FS12



FS12

Steel tip with hardened top.

Particulars:

- special steel material
- accepts different types of earthing wires
- to be used with FS21 leading rod

Area	Cat. no.	Weight	Pcs/pack	Length
70-95 mm ²	FS12	1.3 kg/pack	5	135 mm

FS21



FS21

Leading rod, with a knurled recess for effective locking of the earth conductor. Used for normal and soft soils.

∅	Cat. no.	Weight	Pcs/pack	Length
17 mm	FS21	3.3 kg/pack	5	800 mm

FS31



FS31

Extension rod with locating pin fitting into the preceding tube. For normal and soft soils.

Particulars:

- steel tube, diameter 17 mm
- to be used with FS21 leading rod

∅	Cat. no.	Weight	Pcs/pack	Length
17 mm	FS31	3.9 kg/pack	5	870 mm (incl guiding pin)

FSHD11



FSHD11

Heavy duty special steel tip with hardened top, used for hard and stony soils.

Particulars:

- to be used with FSHD23 leading rod

Area	Cat. no.	Weight	Pcs/pack	Length
25-70 (95) mm ²	FSHD11	1.3 kg/pack	5	153 mm



FSHD23



FSHD23

Heavy duty leading rod with a knurled recess for effective locking of the earthing wire. For hard and stony soils. To be used with the FSHD11 tip.

Ø	Cat. no.	Weight	Pcs/pack	Length
21 mm	FSHD23	5.5 kg/pack	5	800 mm

FSHD31



FSHD31

Heavy duty extension rod, with guiding pin that fits into the preceding tube. For hard and stony soils.

Ø	Cat. no.	Weight	Pcs/pack	Length
21 mm	FSHD31	6.2 kg/pack	5	870 mm (incl guiding pin)

FS41 withdrawal handle



FS41

Withdrawal handle to pull up the top extension rod for re-use. Fits FS and FSHD type rods.

Particulars:

- easy to use, with rubber handle grip
- for FS Ø17 and FSHD Ø21 rods

Dimensions hole	Cat. no.	Weight	Pcs/pack	Length x Width
Ø 18,5 mm and Ø 22,5 mm	FS41	0.42 kg	1	230 x 60 mm

FS62C



FS62C

Driving sleeve used when driving the rods down with a sledge hammer. Must be used to prevent rod end damage.

Particulars:

- specially designed for FS21 and FS31 rods

Cat. no.	Weight	Pcs/pack	Length x Width
FS62C	1.0 kg	1	110 x 45 mm

FS61



FS61

Driving cap used when driving the FS21 and FS31 rods down with a sledge hammer. Used as an alternative to FS62C to prevent rod end damage.

Cat. no.	Weight	Pcs/pack	Length x Width
FS61	0.15 kg	1	58 x 22 mm

FSHD62C



FSHD62C

Driving sleeve used when driving the FSHD type rods down with a sledge hammer. Must be used to prevent rod end damage.

Particulars:

- specially designed for FSHD23 and FSHD31 rods

Cat. no.	Weight	Pcs/pack	Length x Width
FSHD62C	1.0 kg/pack	1	110 x 45 mm



Power hammer driving studs for Elpress deep earthing system

- specially designed for use with Ø17 mm FS type rods. Studs for use with FSHD rods, contact Elpress
- must be used to protect the rod ends from damage and distortion when power hammers are used
- marked with the catalogue number



Power Hammer		Driving tip			kg/1		
Manufacturer	Type	Cat.no.	Shaft Ø mm	Flange length mm	Total length mm	kg/1	Note
Atlas Copco	BBD 12 TS	FS 71 C	19	108	305	1,8	1
Atlas Copco	BBD 12 T-01	FS 72 C	22	108	305	1,9	1
Atlas Copco	Cobra 148/248	FS 72 C	22	108	305	1,9	1
Atlas Copco	Cobra BBM 47	FS 71 C	19	108	305	1,8	1
Atlas Copco	Pico 20	FS 72 C	22	108	305	1,9	1
Atlas Copco	RH 571 5L/5LS	FS 72 C	22	108	305	1,9	1
Atlas Copco	RH 658 5L/5LS	FS 72 C	22	108	305	1,9	1
Atlas Copco	TEX 11-DCS	FS 74 C	22	82	280	1,8	1
Atlas Copco	TEX-11-DKS	FS 74 C	22	82	280	1,8	1
Atlas Copco	TEX 23E	FS 73 C	25	108	305	2,0	1
Atlas Copco	TEX 25E	FS 73 C	25	108	305	2,0	1
Atlas Copco	TEX 31/31s	FS 77 C	32	160	380	2,5	1
Atlas Copco	TEX 41/41s	FS 77 C	32	160	380	2,5	1
Berema	Pionjär 120/130	FS 72 C	22	108	305	1,9	1
Bosch	USH 10	FS 82 C	19	-	272	1,5	1
Bosch	USH27	FS 83 C	29	-	310	2,2	1
HILTI	TE 52	FS 81 C	18	-	265	1,4	1
HILTI	TE72	FS 81 C	18	-	265	1,4	1
HILTI	TE 92	FS 81 C	18	-	265	1,4	1
HILTI	TE 905/TE805	FS 88 C	22	-	288	1,7	
Hunter		FS 73 C	25	108	305	2,0	1
Kango	950	FS 84 C	19	64	289	1,5	1
Stanley	BR 37	FS 74 C	22	82	280	1,8	1
Stanley	BR 45	FS 74 C	22	82	280	1,8	1
Stanley	BR 67 UK	FS 77 C	32	160	380	2,5	1
Stanley	BR 87 UK	FS 77 C	32	160	380	2,5	1
Stanley	DR 19	FS 74 C	22	82	280	1,8	1
Wacker	BHB 14	FS 71 C	19	108	305	1,8	1
Wacker	BHB 25	FS 72 C	22	108	305	1,9	1
Wacker	BHF 25	FS 85 C	27	80	302	2,1	1
Wacker	BHF 30S	FS 85 C	27	80	302	2,1	1
HILTI/Bosch	SDSMax Syst.	FS 81 D	18	-	215	1,4	

Note

1. Also available in a HD-version (ex FSHD71C), for FSHD rode with outer diameter 21 mm.



General deep earthing information

Earthing

An earth electrode is a conductor placed in the soil with the purpose to discharge electrical current from a connected facility.

A customer that buys power expects good earthing. This, is in view of the fact that use of electricity with bad earthing includes a high risk. All suppliers of power must have approved earth electrodes at their facilities. It means that flash-over voltages, which can appear for different reasons, are led into the soil so they do not cause any damages and/or injuries. Earthing serves as, among other things, person protection, property protection, Electro Magnetic Pulses protection, lightning protection and similar.

Approved earthing should include:

- (1) low electrical resistance,
- (2) ability to conduct stable voltage, even at weather changes and
- (3) long life expectancy, ie high resistance against corrosion.

Soil conditions or external conditions

The soil's importance as conductor of electricity is large. This is proven by the fact that the technical specifications and demands, which apply to earthing, will confirm the advantages deep earthing has, both technically and economically, in comparison to surface buried conductors. Conductivity in the soil is made possible through an electrolytic process known as ion conduction. Homogenous particles, such as sand and gravel, are generally non-conductive.

The conductive ability of the soil is therefore dependant of the proportion of saline water that is bound through capillary forces and osmotic pressure in the pores laying between the sand and the hygroscopic humous particles. The water in the lower soil layers generally has a higher percentage of salt than the water in the upper soil layers.

Also the moisture content influences the conductive ability of the soil.

The higher moisture content (%) in the soil, the better conductive ability it has. Normally, the moisture content of the soil varies between 5 - 40 %. At variations to under 14 - 18 %, the conductive abilities become considerably lower. Frost also decreases the conductivity in the soil. It is of great importance to consider all these facts when planning an earth electrode or earthing system.

Weather conditions such as ice, snow, sun, rainfall and wind, greatly influence the upper soil layers (0 - 1,5 m in depth) and therefore the upper layers show the largest variations. The most effective earthing will be achieved when the earth electrode is placed deep enough not to be influenced by changes of the moisture content and temperature in the soil.

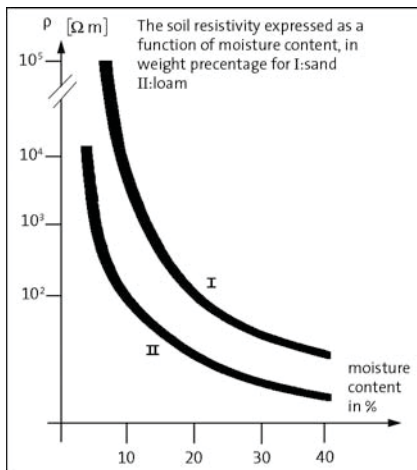

Soil resistivity as a function of the moisture content.

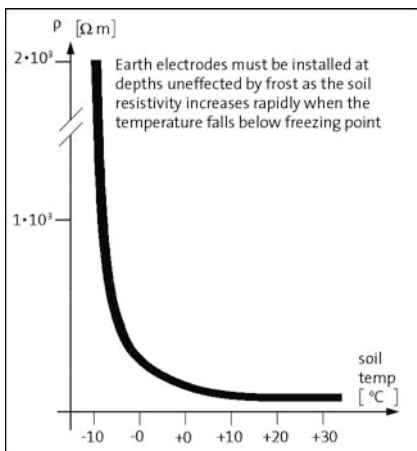

Soil resistivity as a function of the temperature.

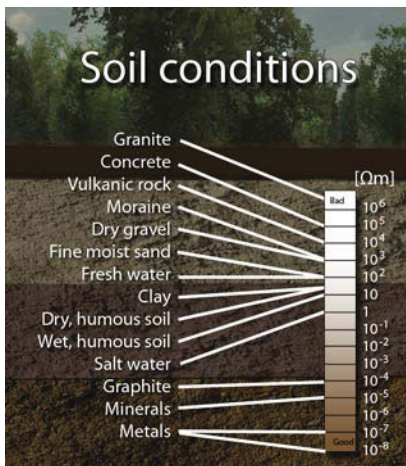

Resistivity in various types of soil.

Resistivity

You declare the quality of the soil's electrical characteristics with help from its resistivity, which is measured in Ωm (previously in Ωcm, 1 Ωm = 100 Ωcm). Therefore, soil with low resistivity (10 - 100 Ωm) has good conductivity. In each case of different type of soil, the resistivity should be measured and the operation is preferably carried out at different times of the year and under seasonal weather conditions. When carrying out resistivity readings today, almost all are exclusively voltage compensated bridges (measuring method from Wenner) with 4 external termination pints, of which 2 are for current electrodes and 2 for voltage electrodes. The termination points are connected to 4 vertical metal rods which are driven into the soil in a straight line with equidistant spacing "a" to a depth of about 0,3 - 0,5 m. (See picture).

On instruments giving a direct reading in ohms, R, the resistivity of the soil can be calculated with the following formula:

$$\rho = 2 \times a \times R \Omega m$$

In non stratified soil the resistivity is independent of the distance 'a'. By increasing the distance 'a' the test current will penetrate deeper into the soil layers and thus the measured resistivity will decrease or increase depending on the true resistivity existing in the soil layer at the depth of l. At approximate calculation of the resistance on a depth of l, the soil resistivity must be measured with a probe distance of a x 0,75 x l.

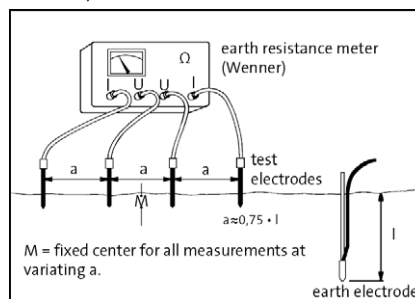

Measurement of earthing resistivity.



Measuring of earthing resistance.



Earthing resistance

Due to the high resistivity of the earth ($10^9 \times \text{resistivity}_{\text{metal}}$) a voltage gradient is built up around the earth electrode in the soil, which decreases with the distance from the electrode. On a particular distance this field gradient can be neglected (distant earth).

The resistance to earth of an electrode is usually measured with the same type of instrument that was used when measuring the resistivity of the soil. At this measurement only one voltage probe and one current electrode is used. The location of probes and electrodes vary between various measuring methods. Out of the two methods to follow, one is very accurate when speaking of measurement techniques whereas the other is a more practical and not so sophisticated.

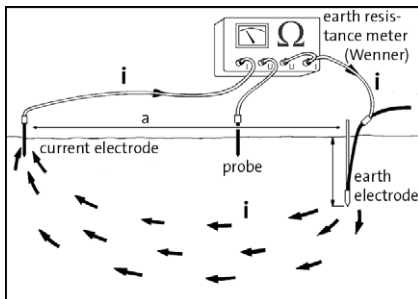

Measurement of earthing resistance - Method 1.

Method 1

(According to the Swedish lightning protection standard SS 487 0110)

This method has a measure deviation of $\pm 2\%$.

General instructions:

- The external current electrode and the probe should be driven in a straight line with the earth electrode, as the picture shows.
- If the soil layers are stratified the measurements should be repeated with the external test probes being driven at alternative distances. The highest of the two values should be used.
- The reliability of the measurement depends on the location of the external current electrode and the probe. Note: The distances in the table below normally give acceptable accuracy of the measurement.
 - earth electrode - probe = $0,5a - 0,6a$
 - earth electrode - current elektrod = a
 - $a \geq 40 \text{ m}$ if $l \leq 4 \text{ m}$
 - $a \geq 10 \times l$ if $l > 4 \text{ m}$

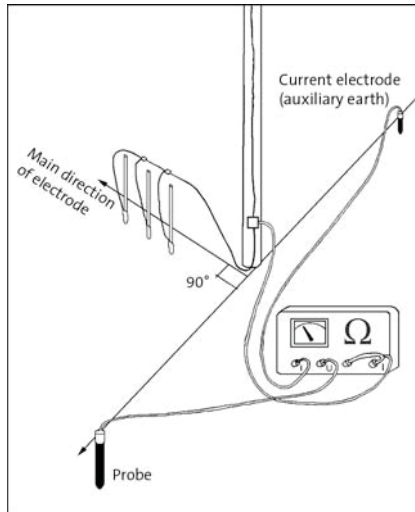

Measurement of earthing resistance - Method 2.

Method 2

This method has a measure deviation of more than 2% in general. It is, however, easier to carry out in practice compared to method 1.

An abridged report of this method will be as follows:

- Probes and electrodes to be located according to the figure, 90 degrees from the main direction of the earthing.
- The location of probe/electrode is the same be it measuring of an individual earthing or an earthing system which means at least 80 m from the earthing.
- Measurement of an earthing system is made by open earthing clamp.
- Measurement of resultant contact resistance of several earthing systems is made by a closed clamp and with the pilot wire connected to the top of the earthing clamp.

With assistance from the conductive ability and the max resistance, that are required according to directives, you can estimate the length of wire required from the formula:

$$l = \rho / R$$

l = length in meters

ρ = earthing resistivity in Ωm

R = earthing resistance in Ω

In our discussion about the advantages deep earth electrodes have compared to surface buried electrodes, we can mention that for the same conductor lengths, the resistance for a horizontal buried electrode is twice as high as for a deep earth electrode, ie:

$$R_0 = 2 \times \rho / l$$

Parallel connection of several earth electrodes is often necessary, for practical

reasons, to achieve a satisfactory low value of the earthing resistance. In order to limit the mutual influence between the individual earth electrodes, the electrodes shall be installed at distances of a of 1,5 times the depth of l . The resulting earthing resistance is:

$$R_{\text{res}} = k \times R_m$$

where R_m is the mean value of the earthing resistances of the individual electrodes. The reduction factor k is obtained from the following table.

No. of parallel earth electrodes	k for $a = 1,5l$
2	0,60
3	0,40
5	0,25
10	0,13

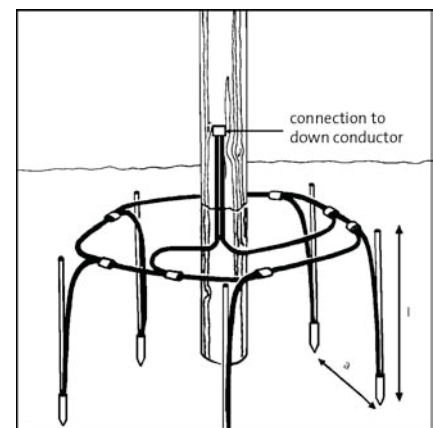

Parallel connection.

From an economical point of view, it can be mentioned that the diameter of the electrode has low influence when calculating the resistance when deep earthing is used. This means that when Elpress deep earthing system with a copper electrode is used, the cost will be lower than when using for example conventional systems. Practically, when it comes to the wire diameter it depends on what currents you dimension the system for and what rules and demands that apply.

Corrosion

The life expectancy of an earth electrode depends on its resistance against corrosion. The assumption for all types of corrosion is an electrolyte which makes it possible to transport metal ions from the anode to the cathode. At the anode the metal atoms in the electrolyte will dissolve and create free positive ions - oxidation - and at the cathode these ions will become neutralized and scale on the metal surface - reduction. At **galvanic corrosion**, which is caused by contact between



two metals, the speed of corrosion is proportional to the galvanic voltage between the metals.

An un-noble metal has higher electro-negative potential than a noble metal and is therefore the anode in a corrosion process.

There is also a clear connection between the speed of corrosion and the earthing resistivity. The speed of corrosion depends on the composition of the soil. Influencing factors are the soil's pH-value, temperature, amount of oxide, amount of water and resistivity. These factors influence the corrosion current, I_c , which is directly proportional to the speed of corrosion. I_c can be decided by direct measuring with an Ammeter or calculated according to the formula below if the contact resistance, R_c , between the two electrodes are known:

$$I_c = U_g / R_c$$

U_g = the galvanic voltage

R_c can in some cases be measured with the same type of resistance instrument that is used when measuring an earth electrode's resistance.

The speed of corrosion is often expressed in $\mu\text{m}/\text{year}$ where 1 μm is 1/1000 of 1 mm and denotes the thickness of the corroded outer metal layer during one year.

The table below shows some practical direction values at various soil resistivities.

Resistivity	Corrosion
$\rho < 1 \Omega\text{m}$	100 $\mu\text{m}/\text{year}$
$\rho = 1-10 \Omega\text{m}$	100-30 $\mu\text{m}/\text{year}$
$\rho = 10-100 \Omega\text{m}$	30-4 $\mu\text{m}/\text{year}$
$\rho > 100 \Omega\text{m}$	neglectable



Notes



General information

Some important points regarding crimping	2
Standards for crimped connections	3
Instructions for operation and safety	4
Service and maintenance	6
Inspection/certification agreement regarding crimp tools	7
Technical information	8
Development - Technical services	9
General points when using Elpress terminals and connectors at high voltages	10



Some important points regarding crimping

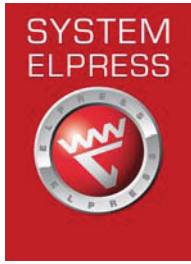

System technique

The technique of crimping a terminal on to an electrical conductor has been used over 60 years and is the dominant connecting technique for power and signal transmission cables.

The most important reasons for the success of this system are **simplicity** and **safety**. Crimping is the **optimum technique** to provide both.

The system contains of, from the smallest to the largest cross section, a previously tested combination of terminal size and tool geometry related to the actual cross section of the conductor.

Different manufacturers choose to apply this combination in different ways. For example, a terminal with little material in the barrel can be crimped with a crimp die designed for this geometry. The same terminal crimped with another die from a different system, where the die is designed for a terminal with a larger barrel, would result in lower crimp reduction which could cause overheating due to poor electrical contact.

Therefore always check that the tools and terminals are tested together. This normally means choosing tools and terminals from the same manufacturer, and the same system.

System Elpress

In order to achieve a secure connection we offer certified solutions of the combination; cable, terminal and tool. This is so that you as customer can feel secure when you use our system and be sure that a safe connection will be made when our products are used correctly.

Variations in the material and crimp geometry

Another factor is variations in the construction and material of the conductor. Most, but not all, power conductors

which have a given size in mm² are designed to comply with IEC 60228 which is an international standard that gives the max conductor resistance per km for each cross section. The possible geometric variations within this standard can be rather large and may influence the final crimp result.

Elpress has considerable experience regarding these variations and of what special actions must be taken to achieve the best crimp quality. Contact us if a special conductor is to be used.

Different conductor materials are often crimped with completely different die geometries. For copper the most common is the **hexagonal crimp**. This shape gives a gentle and mechanically strong crimp with little risk of conductor strands being damaged. When crimping aluminium, it is important to break the layers of insulating oxide as efficiently as possible and the **indent crimp** is the most effective method.

On copper connections, by using simple analysis and tests, it is possible to establish if good results may be obtained on a previously un-tested non standard conductor size. These tests are based on comparison with a large number of existing test combinations. Elpress are happy to perform and discuss these tests together with the user.

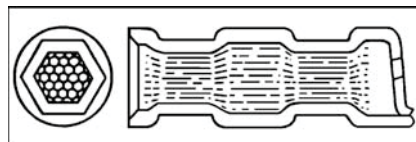

Hexagonal crimping.

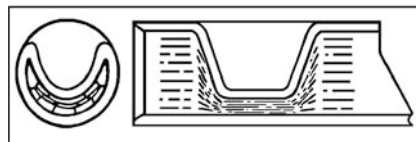

Indent crimping.

Educated operator

Probably the most important "system component" is the operator who must have the opportunity to learn and understand by themselves the simple but necessary conditions that provides a good crimp. A simple product labeling system, easy instructions, job aids and a good basic training must be available. We offer company specific courses in which both

theoretical and practical aspects are included. If possible, the training can be done in the field. We provide instructors and training materials.

Screw connectors

Connection to the conductors is achieved by tightening the screws in the through connector or terminal to a pre-determined torque. Through connectors and terminals are made of aluminium. The terminal palm is made of copper and the accompanying screws Elpress uses are made of brass to reduce friction and facilitate installation.

Tools for assembly can be a spanner/wrench or a battery-operated impact wrench which has a high torque force, > 100 Nm. To facilitate installation there is holding tool, ISL2201, to hold the screw connector in its right position during tightening of the screws. The screw connectors have a partition wall to enable jointing of oil-filled conductors to plastic-insulated XLPE conductors. The screw connectors meet the requirements of IEC 61238-1.

Handles multiple cross section areas

The installation of a screw connector can be done easily without heavy special tools and can withstand several area stages in the same connector, for instance 10-50 mm². The user gets a reduced range of products and a flexible solution.

Washer solution

To reduce the number of variants of the terminals, washers are delivered with the terminals. A washer is always required for connection of the terminal palm to a bus bar with a screw.



Bolts are tightened using a wrench. It is also possible to use a battery operated wrench.



Standards for crimped connections



Electrical standards

There are many different standards within the electrical industry. IEC - the International Electrotechnical Commission - issues international standards which, although not always compulsory, do have strong influence and are used as a basis within the international terminal trade. In Europe, standards are issued by CENELEC and they directly replace the various national standards which may have existed previously. For crimp connections a Cenelec standard was issued during 2003.

In many countries national standards have been in force over a long time. In UK the electrical standards are issued by BSI - the British Standards Institution - and are called **BS standards**. In Germany there are the well known **DIN** and **VDE** standards. In Sweden they are called **SEN** standards and in France **NF**, etc. Even if the new Cenelec standard has been issued, these old standards will still be referred to over many years.

The application of different standards also varies. In some cases a standard must be followed according to instructions from an authority concerned. In some cases there is an agreement between buyer and seller to follow a special standard, while in other instances the user may have an expectation that a relevant standard is complied with.

Within crimping there are many standards all over the world and many of

them have an established position in their home market. Due to the high costs of testing to all these standards, most products are tested only to the standard of the country of origin and it is therefore important to know what that standard contains.

Standards for cross section area range above 10 mm²

Prior to August 1993, there were no international testing norms for terminals designed for **cable sizes above 10 mm²**. Then **IEC 61238:1** was issued which states how both crimped and screwed terminals and connectors on power cables should be tested. Because it is relatively new, it will take several years before there is extensive testing carried out according to the requirements of this standard and its **update from 2003**. Until then one has to rely on the national standards against which there is also considerable practical experience which verifies their validity.

The following testing standards are some examples of old standards now to be replaced by **EN -IEC61238-1**.

Country	Copper terminals	Aluminium terminals
SE	SEN 245010	SEN 245012
FI		SFS 2663 T2
DE	VDE 0220:1	VDE 0220:2
GB	BS 4579:1	BS 4579:3
FR	NF C20-130	NF C63-061/A

In addition to these performance **standards**, which typically involve testing by pull-out, temperature cycling and short-circuiting, there are **standards based on dimension** of the products which mainly apply in Germany and France.

Standards for cross section area range below 10 mm²

Within the cross section area range below 10 mm², there are a great number of standards based on dimension, especially

within DIN. Testing standards exist for some terminal types, for example **DIN 46249** for roll crimped receptacles or **SEN 245010** for tube and sheet-metal terminals from 0.75 mm².

Especially within the pre-insulated terminal group, American norms from the Underwriters Laboratories, UL, are sometimes applied such as UL 310, UL 486.

Elpress experience to choose of standard

It is in many cases acceptable for a supplier and a user to state what standard a terminal should completely or partly comply with. Elpress normally comply with Swedish, German, US and UK standards depending on what market the product is designed for and Elpress has therefore had vast experience when it comes to choice of standard. Contact us for further information.





Instructions for operation and safety

The method of crimping requires very high forces. Elpress hydraulic and mechanical tools provide these in the safest way. Without proper instructions being available and carefully followed, full safety can however not be achieved. Every Elpress tool is accompanied by detailed instructions of how to use the tool. Read these instructions very carefully prior to use.

Correct use of the tools:

- increases productivity
- increases life expectancy
- ensures the quality of the operations
- minimizes the risk for accidents

Safety rules

Here are some simple and common rules which Elpress recommend all users to apply:

- Before crimping, a careful **visual inspection** of the tool should be performed. Pump, crimp tool, presshead, forks, connections, hoses and other accessories are checked to ensure that they are clean and without defects. Check that the accessories are correctly inserted into the tool before use.
- All operators must wear **safety equipment** such as protective goggles, gloves and safety shoes. This is a general precaution against working injuries and is normally a requirement according to the local industrial safety rules.
- The pressure in the hydraulic pumps must be checked regularly.
- Hydraulic pressure should not be applied in a hose which is sharply bent. The hose is specially made for high operational pressure and **cannot be replaced** by any other type.
- The tools must be calibrated at usage related intervals (at least yearly), for example with a gauge. Contact Elpress for more information.
- Check that the right tool and die-set combination have been chosen for the terminal and conductor which is to be crimped.
- Hydraulic tools must never be carried by the hose or coupling.
- Be careful, do not drop heavy objects on the hydraulic hose. It can damage the reinforcement and cause leakage. If a leak-

age occurs, oil at high pressure can pierce the skin with resulting internal injuries. In such cases always seek medical advice at once.

- Check that the work object is electrically switched off before the crimping starts. The tools are not designed for use on live circuits.
- Remember that all crimping tools deliver high forces. Do not stand in front of a tool in the direction of the pressforce.
- Be aware of the risk of pinch and cut injuries when operating. This includes all types of crimp tools and cable cutters.
- If there is a suspected defect on a crimping system, always contact Elpress authorized service department. Do not use the part in question until serviced.

Checking crimp results

Ensure that a tool has performed the correct crimp and the desired deformation is achieved. This deformation provides mechanical resistance as well as excellent electric characteristics.

The following is considered for copper **terminals and connectors**:

- Inspect the measure "N" on the hexagonal faces where the impressions of the crimp dies are made. See measuring points on table below.
- Measure with a sliding caliper on either side of the impression and compare with the "N"-dimension in the table. In the cases where the impression is missing, the "N"-dimension is measured in the direction of the crimp force. Note that the hexagon is often not symmetric.
- If the result of measuring exceeds the "N"-dimension (according to the table on the next page) after a correctly performed crimp, contact Elpress authorized service department.

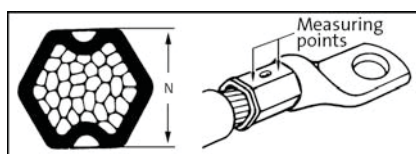

KRF/KSF types		
Cu conductor mm ²	Crimp dies No.	max N mm
10	8	6,3
16	9	7,3
25	11	8,8
35	13	10,2
50	14,5	11,4
70	17	13,4
95	20	16,4 (B-dies)
95	20	15,8 (TB-dies)
120	22	16,3
150	25	20,3
185	27	20,5
240	30	23,3
300	32	24,5
400	38	30,5
500	42	30,5
630	53	38,5
800	53	38,5

Type KRF/KSF with DUAL-dies		
Cu conductor mm ²	DUAL-dies No.	max N mm
10	DB/DCB8	6,7
16	DB/DCB 9	7,7
25	DB/DCB11	9,2
35	DB/DCB13	10,8
50	DB/DCB14,5	11,8
70	DB/DCB17	13,8
95	DB/DCB20	16,0
120	DB/DCB22	17,9
150	DB/DCB25	20,3
185	DB/DCB27	21,9
240	DB/DCB30	24,1
300	DB/DCB32	25,9

KRD/KSD types		
Cu conductor mm ²	Crimp dies No.	max N mm
10	-	-
16	8	6,3
25	9	7,3
35	11	8,8
50	12	10,2
70	14	11,6
95	16	13,2
120	19	15,4 (B-dies)
120	19	15,2 (TB-dies)
150	22	16,3
185	25	20,3
240	27	20,5
300	30	23,3
400	32	24,5



KRT/KST types		
Cu conductor mm ²	Crimp dies No.	max N mm
10	7	5,9
16	8,5	7,5
25	10	8,2
35	12	10,2
50	14	11,6
70	16	13,2
95	18	14,0 (B-dies)
95	18	14,0 (TB-dies)
120	19	15,4 (B-dies)
120	19	15,2 (TB-dies)
150	22	16,3
185	24	17,7
240	26	19,5
300	30	23,3
400	32	24,5

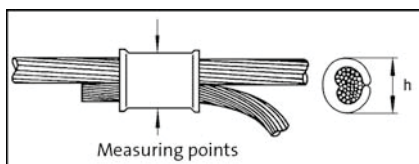

Oval crimping

For Cu branch connectors, the "h"-dimension must be measured. This is made on the maximum height of the crimped oval, preferably with a sliding caliper. The dimensions are compared with the table below.

If the result of measuring exceeds the "h"-value after a correctly performed crimp, contact Elpress authorized service department.

See measuring points on above picture.

Crimp dies No.	C sleeve	max h mm
C4	C4	9,6
MBC4	C4	9,5
C5	C5	12,2
C6	C6	15,2
C8-9	C89	21,2
C11	C11, C11-8 and 11-9	22,2
C13	C13, C13-8, C13-9 and C13-11	25,8
C15	C15, C15-8, C15-9, C15-11 and C15-13	29,2
C16 25C16	C16, C16-9 and C16-13	37,6
40C18 25C18	C18, C18-8, C18-9, C18-11, C18-13, C18-15, C18-16, C21-8, C21-9, C21-11, C21-13 and C21-15	43,6
40C21 25C21	C21, C21-18, C23 and C23-16	53,6

IMPORTANT! When using Cu branch connectors the tap off conductor shall always pass through and project to a length of more than 60 % of the Cu conductor diameter.

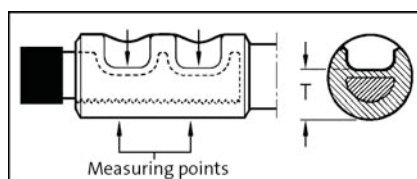

Punch crimping

For Al-terminals the "T"-dimension should be checked. It is measured at the bottom of the indent that the punch has made. This is most suitably done with a special caliper which can be ordered from the nearest Elpress retailer. Compare measurement with "T"-dimensions in the table below.

If the result of measuring exceeds the "T"-value after a correctly performed crimp, contact Elpress authorized service department. See measuring points on previous picture.

Al conductors mm ²		Tools		T
Str.	Sol.	Matrix	Punch	mm
16	25	P13M	P13D	6,8
25	35	P13M	P13D	6,8
35	50	P20M	P20D	10,8
50	70	P20M	P20D	10,8
70	95	P20M	P20D	10,8
95	120	P25M	P25D	13,5
120	150	P25M	P25D	13,5
150	185	P25M	P25D	13,5
185	240	P32M	P32D	18,4
240		P32M	P32D	18,4
300		P36M	P36-40-44D	21,0
300B		13P37M	13P37D	*
400		P40M	P36-40-44D	22,8
400B		13P37M	13P37D	22,0
500A		P52M/ P2552M	P52D- P2552D	31,0
500B		P44M	P36-40-44D	24,5
630A		P52M/ P2552M	P52D- P2552D	31,0
630		W60M	W60D	36,0
800		W60M	W60D	36,0
1000		W60M	W60D	36,0
1200		W70M	W70D	41,0

Str. = Stranded Sol. = Solid
* contact Elpress

Palm bolt torques

Recommended torques for nuts and bolts, electro-plated type, lubricated threads, strength class 8.8, which are used with suitable washer, to connect cable lugs, are found below.

Stud-size	Torque (Nm)	Stud-size	Torque (Nm)
M5	5	M12	70
M6	9	M14	110
M8	21	M16	170
M10	41	M20	340

For the other stud types, contact Elpress.



Service and maintenance

Elpress crimp tools and power units are designed for long life with maintained high personal safety and performance. All types of professional crimp systems develop high forces and must therefore be handled with care. Here are some examples of forces developed in Elpress crimp tools:

Mechanical tools **5-60 kN**

Hydraulic tools

PVL611, V611, PV600, **60 kN**

V1300(C), V1311(C), **130 kN**

PVL1300-system **130 kN**

V250-system **250 kN**

V1470-system **400 kN**

Note: 10 kN is approx. 1 ton

Regular inspections must be made to ensure the high safety and performance of Elpress tools. These pieces of advice may serve as a guide to perform these inspections.

When you suspect a malfunction or a fault, always contact Elpress or an Elpress representative.

Also see information of inspection/certification agreement for Elpress tools.

Inspection of crimp heads and hydraulic hoses

	Before use	Regularly (1-3 t/year)	Notes
Outer defects	X		
Cracks	X		
Free from dirt and other obstructions	X		
Oil leakage	X		
Protection cap	X		
Connection/quick coupling	X		
Maintenance, service		X	Done by auth. service units

Inspection of hydraulic pumps

	Before use	Regularly (1-3 t/year)	Notes
Outer defects	X		
Cracks	X		
Free from dirt and other obstructions	X		
Oil leakage	X		
¹ Check of oil pressure		X	P4000, PS710
² Check of crimp force		X	V611, V1311
Maintenance, service		X	Done by auth. service units

¹ For measuring this pressure we recommend the pressure gauge 10020 for the pumps P4000 and PS710. The pumps should release at 630 bar, which is the standard pressure setting at delivery. The pressure gauge 10020, ø 100 mm, with a maximum force indication pointer and snap-coupling for Elpress pumps, has an industrial design with house and cap from black enamelled steel. Measuring range is up to 1000 bar.

² For measuring this force we recommend the power gauge M1300. It can also be used for inspection of the pumps P4000 and PS710, under the assumption that they are connected to a V1300-presshead. When using this power gauge the force should release at 130 kN. If the pressure is too low or alternatively too high, or if the pointer "falls" quickly between the pump strokes (only for the pump P4000 and the tool V1311), the pump must be sent to an Elpress authorized service unit.

The pressure gauge M1300, ø 160 mm, has a maximum force indication pointer and a special connection for the V1300-system. It has an industrial design with house and cap from black enamelled steel. Measuring range is up to 200 kN. (M1300 is mainly designed for use at service departments.)

Inspection of forks, die holders, crimp dies, punches and matrixes

	Before use	Regularly (1-3 t/year)
Outer defects	X	
Cracks	X	
Free from dirt and other obstructions	X	
Quick coupling	X	
Spring ball locking	X	
¹ Inspection of crimp dies		X

¹ Contact Elpress for more information.

Inspection of mechanical hand tools

	Before use	Regularly (1-3 t/year)
Outer defects	X	
Cracks	X	
Free from dirt and other obstructions	X	
Wet oiling of moving parts		X
¹ Calibration		X

¹ The tools are calibrated with a gauge. Contact Elpress for more information.



Elpress service department, calibration of crimp tool PVL1300.



Inspection/certification agreement regarding crimp tools

General

To safeguard the tool quality, Elpress can offer our customers maintenance and certification agreements. In such an agreement the inspection intervals, based on use, are established. Thereafter we call in the tools and perform the necessary actions to achieve a trouble-free function. These actions are recorded and a certificate is sent back with the tool.

The inspections may also be performed at the customers premises.

Certifikat		Certificate	
<p>Detta certifikat anger de viktiga utgångsvärdena för det aktuella verktygets presskraftsmått och handtagstappning. Dessa värden bör förtgå- ande kontrolleras under verktygets användning.</p>		<p>This certificate states the important initial values for the crimp nest heights and the handle pre-load of this tool. These values should be regularly checked during the use of the tool.</p>	
Verktyg Typ	GSAD760	Tool Type	Serial number
Handtagstappning	217 N	Mått/Measured	Tillåtet/Accepted
Presskraftshöjd			
	Rör: 2,26 mm		2,20 - 2,40 mm
	Blå: 2,70 mm		2,65 - 2,85 mm
	Gult: 3,38 mm		3,35 - 3,55 mm
		Handle pre-load	
		Röd	
		Blå	
		Yellow	
SPECIFIKATIONER OCH MÄTNING		SPECIFICATIONS AND MEASURING	
<p>1. Förlängningen mäts 40 mm från handtag- ändan. Mätutrustningen kalibreras löpande spårbart mot internationell normal. certifikat nr H177080130.</p> <p>2. Presskraftshöjden mäts mitt i det förlängda staget. Mätutrustningen kalibreras löpande spårbart mot internationell normal. certifikat nr H189080101.</p>		<p>1. The handle pre-load is measured 40 mm from handle end. The measuring equipment is regularly calibrated against an internationally traceable standard. Certificate No. H177080130.</p> <p>2. The crimp nest height is measured in the middle of the pre-loaded nest. The measuring equipment is regularly calibrated against an internationally traceable standard. Certificate No. H189080101.</p>	
Datum/ställe Signatur/signatur			
 Sveig Mattsson Kvalitetskontrollant/Quality Inspector			
ELPRESS AB P.O. Box 186 SE-87224 KRAMFORS Sweden		Tel: +46 (0)42 71 71 00 Fax: +46 (0)42 71 71 11 E-mail: info@elpress.se Webb: www.elpress.se	

Elpress certificate.

Certification scope

The inspection/certification is done in accordance with Elpress' current instructions for the tool in question and forms a part of Elpress' ISO 9001 certification. After acceptance a certificate is issued. All inspected tools have signed acceptance labels.

Dies are marked with colours and number to indicate last month for next inspection/calibration. Alternative marking to customer specifications can be done. Non-functioning and/or inspectable tools are repaired after customers agreement.



Elpress certified tool GSA0760.

Preventive maintenance may comprise:

Elpress Basic

Elpress Basic service agreement includes following points:

- Preventive maintenance, calibration with certification
- General inspection of the tool
- Safety aspects in accordance with declaration of conformity (Compliance with Machine Safety Directive, Low Voltage Directive, EMC Directive)
- Function test
- Checking of accessories, e.g. crimp dies etc.
- Issue of Certificate

The inspection follows Elpress final inspection and acceptance inspection requirements.

Elpress Advance

Elpress Advance service agreement includes following points:

- Elpress Basic + corrective maintenance
- Includes the Calibration/certification and wear & tear repairs at a fixed price.



Elpress hydraulic handtool, V1311.

Spare parts

Exchange spare parts deemed by our service staff to be necessary to bring the tool to a functional state are charged in accordance with current price lists. Before significant repairs are done, the customer is contacted.

Note that only authorised service units, with access to technical information, may repair Elpress products.

All hydraulic tools works with high pressure technology, which requires special knowledge.



B-dies.

Terms

- Exchange equipment may normally be offered if the customer so needs until his equipment is ready to be returned.
- Such exchange equipment must be sent back complete with its packing and without delay to Elpress.
- Possible damage will be repaired and charged.
- General materials used when repairing the tool will not be charged separately.
- Maintenance agreements are set up for 12 month periods and our fees are charged in advance. Notice of termination is three months before the end of a period.

More information

For more information, contact your nearest Elpress representative. Elpress own service units are located at:

Elpress AB, Kramfors (HQ)

P.O.Box 186
SE-87224 Kramfors, Sweden
Telephone +46 612 71 71 00
service@elpress.se

Elpress Germany, Viersen

Telephone +49 2162 9319-0
sales@elpress.de

Elpress Denmark, Silkeborg

Telephone +45 86 81 61 11
salg@elpress.dk

Elpress China, Beijing

Telephone +86 10 65005642
info@elpress.com.cn

Contact Elpress for information about your nearest Elpress authorized service partner or see our homepage for latest information.



Technical information

Materials for connections

Elpress uses copper, brass and aluminium as termination materials. The copper and brass products are in most cases electroplated with tin to achieve increased protection against corrosion. The copper in a bimetallic (copper-aluminium) terminal is left unplated on the palm. As insulation material for the pre-insulated terminals, polycarbonate is mainly used.

Brass

Brass is mainly used for connections in the cross-section area up to 6 mm², where good spring properties are required. Brass is an alloy metal comprising 70 % copper and 30 % zinc with excellent cold forming property.

Copper

Copper has always been used in electrical connections. Elpress uses copper of at least 99,9 % purity in the terminals. The advantages of such copper are,

- high conductivity
- high corrosion resistance
- good deformation properties
- good jointing ability

During manufacturing, the crimp barrel is annealed to achieve a good deformation around the conductor when crimping. This gives a crimped connection with low contact resistance and good mechanical characteristics.

Aluminium

Aluminium used for connectors and terminals has a purity of at least 99,7 % and its good characteristics are as follows,

- low weight
- strong, in relation to its weight
- good conductivity, around 60 % of that of copper
- easy to work

Conductor design

Below please find references to information from standards in force which might be of interest.

IEC 60228, which gives:

- Information about materials, constructions and resistance values for both copper and aluminium conductors.
- Class 1: solid conductors
- Class 2: stranded conductors
- Class 5: flexible conductors
- Class 6: high flexible conductors

Cross-reference table for AWG/MCM to corresponding cross section in mm²

AWG No	Area mm ²	MCM No	Area mm ²
36	0,013	250	127
34	0,020	300	152
32	0,032	350	177
30	0,051	400	203
28	0,080	450	228
26	0,13	500	253
24	0,20	550	279
22	0,33	600	304
20	0,56	650	329
19	0,65	700	355
18	0,82	750	380
17	1,04	800	405
16	1,31	850	431
15	1,65	900	456
14	2,08	1000	507
13	2,62	1100	557
12	3,31	1200	608
11	4,17	1300	659
10	5,26	1400	709
9	6,63	1500	760
8	8,37	1600	811
7	10,6	1700	861
6	13,3	1800	912
5	16,8	1900	963
4	21,2	2000	1013
3	26,4		
2	33,6		
1	42,4		
1/0	53,5		
2/0	67,4		
3/0	85,0		
4/0	107		

Notes

1. The information in this table is derived from catalogues distributed by cable suppliers and does not relate to official standards.
2. The cross sections that relate to AWG vary depending on different designs of the conductors, ie number of strands.
AWG > 20 relates to solid conductors.
AWG ≤ 20 relates to multi-strand conductors.
The exact cross sections for specific number of strands can be found in cable-supplier catalogues.



Development - Technical services

Elpress is one of Europe's leading manufacturers of electrical connection crimping systems and has more than 50 years experience of applications, from nuclear power plants to small electrical units.

Exposure to mechanical and thermal loads is especially relevant to electrical connections.

Therefore Elpress devotes large resources to achieve commercial and technical success through an ongoing product development towards better user economy, quality and performance.



Testing of connections at the Elpress laboratory.

For this purpose Elpress have a modern laboratory with equipment to perform:

- High current load tests
- Mechanical tensile strength tests
- Cyclical thermal load tests
- Vibration tests
- Corrosion cabinet tests
- Resistance measurements etc.
- Hydraulic impulse test

The laboratory function also includes theoretical studies, prototype generation, technical documentation and advice.

The skill of the staff together with good laboratory and computer equipment form strong competitive advantages both when it comes to consulting services and developing projects.



Laboratory report.



Measuring of resistance in Elpress laboratory.



General points when using Elpress terminals and connectors at high voltages

Terminations

The modern and easy to use termination kits for 12 to 36 kV XLPE-insulated cable, which consist of prefabricated modules or even complete terminations, give no or very few restrictions in using terminal lugs of AK, AKK or KRF types. Included are also the so called "pins" of type designation AKP.

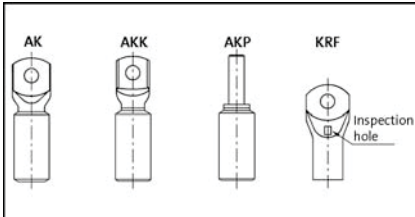

An important consideration when terminating an outdoor copper cable with a copper terminal: The KRF type has an inspection hole which after assembly preferably should be made watertight. Your supplier of termination kits can give you his specific solution.

When using terminals of AK, AKK or AKP types at high voltages, there are today complete solutions for end terminations up to 84 kV both of heat shrink and push-on types.

When in doubt, always consult your supplier of end terminations for his specific solution in matters related to technical details upon performance.

When performing an end termination for oil impregnated paper cable where an oil tank is used, most often the supplier has his specially designed solution.

Elpress terminal lugs of AK and AKK are used with a so called "dry" end termination.

Connections

XLPE to XLPE

Today there are commonly four types of connections used within voltage area 12 to 36 kV. These are: tape, heat shrink, cold shrink, and pre-fabricated (push on) connections. Most of these connections can use Elpress through connectors of the AS, AKS and KSF/KSD/KST types.

Special connectors with cone shaped ends are normally not required today within these voltages.

Different connection kit suppliers recommend different techniques to deal with indent cavities, space between cable insulation and connector and etc.

It is important to follow the supplier instructions when carrying out these assemblies. If you are uncertain, or if the assembly instructions do not give you answers to your questions, consult your supplier.

At higher voltages, for example 52 and 84 kV, there are other requirements on the connectors depending on the connection design. There are, however, solutions where "normal" connectors are used together with additional materials in the voltage range up to 145 kV.

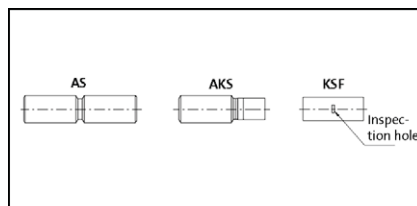

Through connectors for XLPE paper insulation

When making a connection between cables with oil impregnated paper insulation and XLPE insulation at 12 kV and above, through connectors **with partition** should be used, irrespective of connecting method or manufacture. The through connectors of **AS, AKS and KSFM** types always have this partition.

Through connectors for paper insulation to paper insulation

When connecting two cables with oil impregnated paper insulations against each other, through connectors of AS, AKS and KSF/KSD/KST types can be used both in case of an oil tube connection or a heat shrink connection.

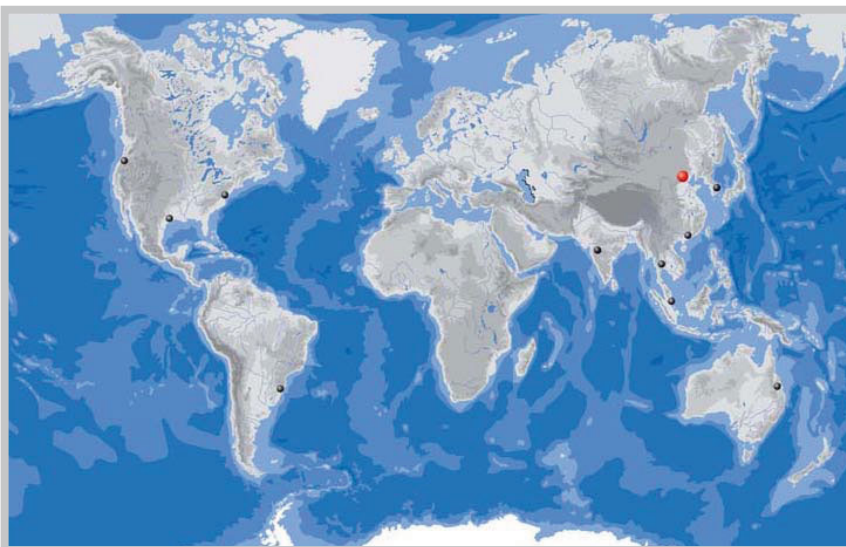
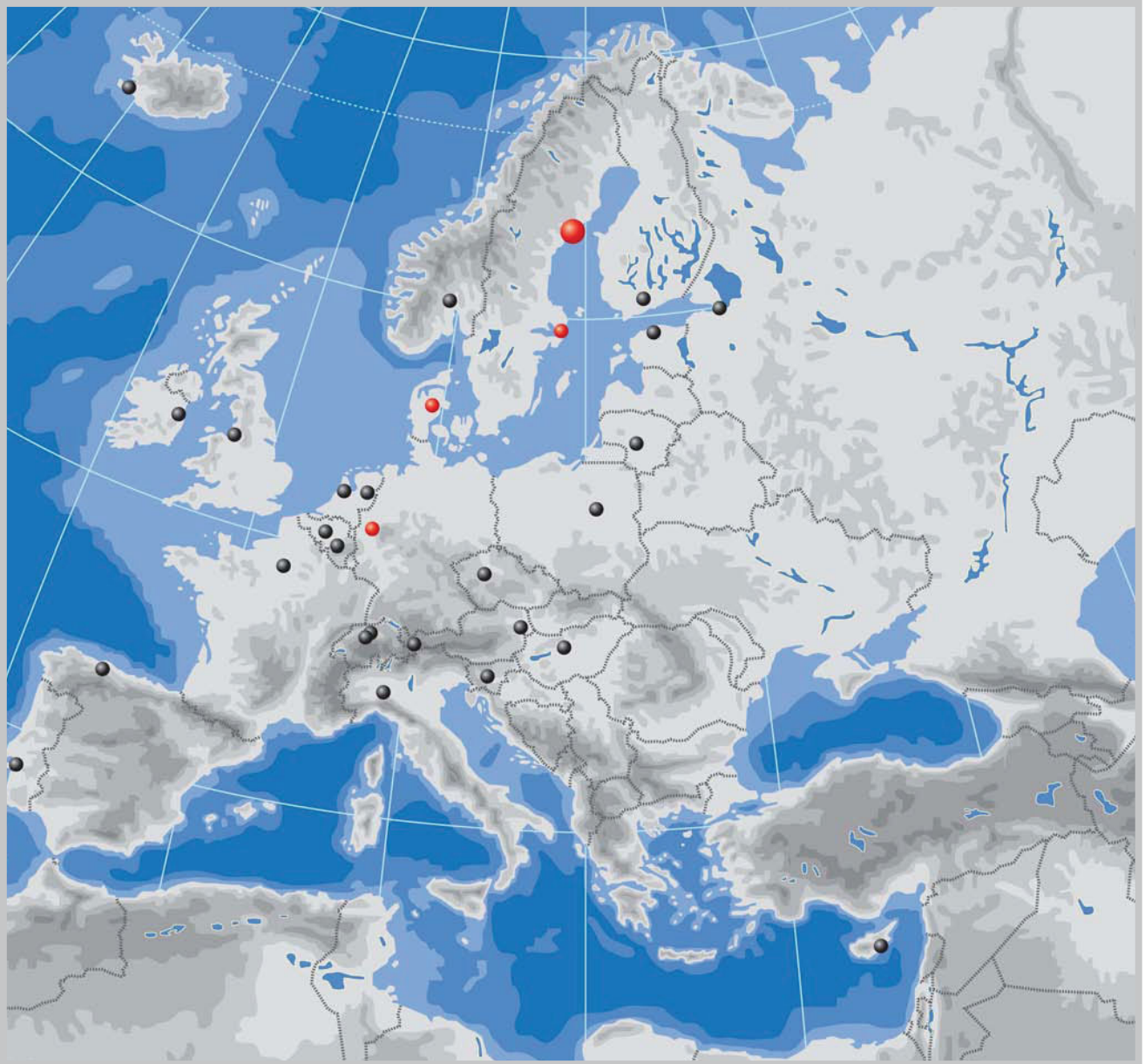

- Elpress head office and production in Kramfors, Sweden
- Subsidiaries and sales offices
- Representatives

Sollefteå Tryckeri AB 2012. Photo: Polyfoto and Elpress AB.



System Elpress symbolizes our **cornerstones** - safety and quality. In order to achieve a secure connection we offer **certified solutions** of the combination cable, terminal and tool.

For the installation to be accurate, the installer should undergo training in crimping technology at **Elpress Academy**.

For non-standard solutions you can **consult** us and let our own production and laboratory verify your solution.

A preventive **service** maintenance of the tool is the base for the system to work.

Certification, Academy, Consulting and Service is System Elpress
- your secure connection!



Elpress has been developing, manufacturing and marketing complete cable crimping systems for electrical connectors since 1959.

The Elpress Group, consisting of the Elpress and ABIKO business areas is owned by Lagercrantz Group AB. Elpress head office and factory is located in Kramfors, Sweden.

Subsidiaries Elpress GmbH, Elpress A/S and Elpress (China) Ltd. with local warehouses in Viersen/Germany, Silkeborg/Denmark and Beijing/China.

Elpress AB · P.O. Box 186 · SE-872 24 KRAMFORS, Sweden
Tel: +46 612 71 71 00 · Fax: +46 612 71 71 51
E-mail: sales@elpress.se · www.elpress.net

ELPRESS[®]